

The right temperature worldwide

LAUDA
brinkmann



LAUDA – the big one

Thermostats, Circulation chillers, Water baths

Overall Brochure 2010/2011

NEW

with LAUDA ECO

LAUDA – the big one – Overview

Aqualine
25...95 °C

The universal **water baths** for the laboratory
from **25 up to 95 °C**

Alpha
-25...85 °C

Heating and cooling thermostats
for cost effective thermostating in the laboratory
at temperatures from **-25 up to 85 °C**

ECO
-50...200 °C

NEW

ECO replaces Ecoline Staredition

Heating and cooling thermostats
for economical thermostating in the laboratory
from **-50 up to 200 °C**

Proline
Proline Kryomats
-90...300 °C

NEW

Proline Kryomats replace
RUK/RUL Ultra Kryomats

Heating and cooling thermostats
with temperatures from **-90 up to 300 °C** for
professional use in materials testing, research
and quality control

Ultra USH High-temperature thermostats
20...400 °C

High-temperature thermostats for special use for
example in process engineering at temperatures
from **20 up to 400 °C**

Integral T
Integral XT
-90...300 °C

NEW

Integral XT 280

Process thermostats for professional external
thermostating across a wide temperature range from
-90 up to 300 °C

WK class
-30...40 °C

Circulation chillers with closed cooler circuit for
continuous nonstop work in research, technology
and production at temperatures from **-30 up to 40 °C**

Calibration thermostats
Digital thermometers
-40...300 °C

Calibration and adjustment with
LAUDA calibration thermostats at
temperatures from **-40 up to 300 °C**

Additional devices

Additional devices
Immersion coolers, through-flow coolers,
circulation heat exchangers (system separators)

Accessories
Heat transfer liquids
Software

Accessories p. 84
Heat transfer liquids p. 86
Software p. 87

Technical data
Power supply variants
Glossary

Technical data p. 88
Power supply variants p. 98
Glossary p. 102





-90 °C -85 °C -40 °C 0 °C 100 °C 200 °C 300 °C 400 °C



from page 10



from page 14



from page 20



from page 32



from page 52



from page 56



from page 68



from page 76



from page 81

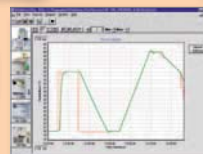
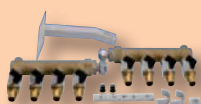

from page 84

LAUDA Technical data

Technical data

Model	Capacity	Temperature range	Power
...

LAUDA Voltage variants

Voltage variants

Model	Voltage	Power
...

LAUDA Glossary

Glossary

Term	Definition
...	...

from page 88

Advantages



Large selection

LAUDA has the right solution for almost any requirement. The water baths and the new, high-value LAUDA Alpha heating and cooling thermostats are the first choice for routine tasks. The ECO and Proline thermostats allow temperature control that is both professional and economical. High cooling capacities and rapid cooling rates are provided by the new Proline Kryomats and the high-performance Integral T und Integral XT process thermostats ensure lightning-speed temperature changes with external temperature regulation.



Convenient use

LAUDA equipment stands out for its excellent handling, optimum ergonomics and intuitive operation. As such, the removable Command remote control allows for rapid changes to operation settings. The self-adaptation of the controller is new and already integrated into all LAUDA Proline cooling thermostats with a Command control element as well as all LAUDA Integral XT process thermostats. It automatically calculates the optimum control parameters for different applications.



Superior quality

For more than 50 years constant temperature equipment and measuring instruments of outstanding quality have been engineered, designed and fabricated by LAUDA. Since the very beginning the owners and the management of LAUDA have been committed to their customers and partners worldwide and concentrated all their efforts on providing the global laboratory community with the highest possible standards according to usability, safety, ease of handling and the proverbial LAUDA durability.



Industry leading safety concepts

All products are compliant with the strictest safety requirements and constraints. Consideration is given to all the relevant DIN and international standards such as IEC, UL and CSA. Furthermore, intelligent technologies and sophisticated safety concepts provide a good feeling to any application. As such, the LAUDA Proline and ECO, for example, have "double safety circuit" technology with reciprocal checking μ -controllers, which switch off the equipment in the event of a fault. The electronic low-level protection detection of the ECO for operation only when the function is fault-free.



First class support – internationally

"We are there". The LAUDA team at our headquarters and in the international subsidiaries and agencies, the professionally and comprehensively trained sales representatives, and the staff of the specialist laboratory facilities provide friendly, fair and competent advice.

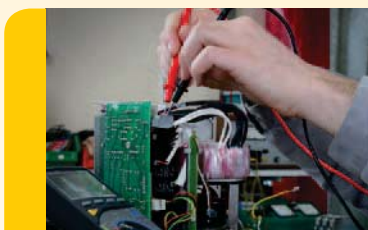

Reliable service

LAUDA equipment is known for its robustness and durability. However, should you ever need support – usually after many years of installation – we are there for you: as a LAUDA customer, you have access to comprehensive services, ensuring greater flexibility and profitability. One thing is certain: LAUDA service will not let you down.

Family Company with Tradition

- 1956** Dr. Rudolf Wobser founds the MESSGERÄTE-WERK LAUDA Dr. R. Wobser KG in Lauda in the region of Baden.
- 1964** Birth of the heating and cooling systems for industrial thermostating tasks. Three years later: development of the first tensimeters and film balances.
- 1977** After the death of the father, Dr. Rudolf Wobser, Dr. Gerhard Wobser and his brother Karlheinz Wobser take over the management as partner with unlimited liability.
- 1982** Launch of the world's first mass-produced thermostats using microprocessor technology. Proportional cooling and external control are further sensational inventions.
- 1989** As part of the expansion of the range of products, the MESSGERÄTE-WERK LAUDA is renamed LAUDA DR. R. WOBSEY GMBH & CO. KG.
- 1994** The first circulation chillers of the WK class put an economical end to the wasteful use of precious drinking water as a coolant. A new generation of compact thermostats is introduced. The high quality of all LAUDA products is confirmed upon certification according to DIN ISO 9001.
- 2003** Karlheinz Wobser retires. Dr. Gunther Wobser, part of the company since 1997, is appointed managing partner.
- 2005** On 1st January, the founding of LAUDA France heralds the start of a new age of internationalisation. This first company outside Germany supports the local agencies with customer advice and care.
- 2006** On 1st March, LAUDA celebrates the 50th anniversary of the company. Two months later, LAUDA founds subsidiary LAUDA Wostok in Russia – another milestone in the internationalisation of the company.
- 2008** LAUDA consistently continues the global expansion strategy with the founding of subsidiaries LAUDA America Latina C.A., LAUDA China Co., Ltd. and LAUDA-Brinkmann, LP. USA. With the new production hall plus office building and an investment volume of around 3 million Euro, the heating and cooling systems business unit gained space for additional growth.
- 2009** At ACHEMA, LAUDA presents an equipment showcase. All of the staff from the six foreign LAUDA subsidiaries meet for the first time at the LAUDA World Meeting
- 2010** In March, after more than 32 years, Dr. Gerhard Wobser retires from his function as Managing Director. His son Dr. Gunther Wobser becomes sole Managing Director of the company.



The Managing Director
Dr. Gunther Wobser



Company founder
Dr. Rudolf Wobser



Karlheinz Wobser



Dr. Gerhard Wobser

LAUDA, Ultra-Kryomat, Kryomat, LAUDA Vario pump and iVisc are registered trademarks of the LAUDA DR. R. WOBSEY GMBH & CO. KG

With roughly 290 employees, more than EUR 40 million in annual turnover and six foreign subsidiaries, LAUDA is the global leader in the manufacture of innovative thermostatic equipment and systems for science, application technology and production, as well as for high-quality measuring devices. With more than 50 years of experience and a unique product portfolio ranging from compact laboratory thermostats to customised heating and cooling system projects with more than 200 kilowatts of cooling power, LAUDA is the only company that can guarantee optimized temperature throughout the entire value-added chain for its 10,000 plus customers worldwide.

Quality products from LAUDA keep temperatures constant to an impressive 5 thousandth °C or make targeted changes in an area spanning -100 to 400 °C. Through active cooling or warming, production processes are accelerated or, indeed, made possible in the first place. In such cases, LAUDA, for example, replaces the uneconomical mains-water cooling with environmentally friendly and cost-efficient devices or, alternatively, uses existing forms of primary energy such as thermal discharge. LAUDA measuring instruments determine the surface tension, tension limit and viscosity of liquids precisely.

As a highly specialised niche provider, LAUDA ranks either first or second in almost all future-oriented sectors. In the semi-conductor industry, all the renowned manufacturers and suppliers place their trust in LAUDA thermostats and heating and cooling systems. LAUDA quality products also enable both the research and mass production of vital medicines. In the growing medical technology market, recirculating coolers made by LAUDA cool patients and guarantee safe open-heart surgery. Further principle applications include material inspection, biotechnology and the cooling of laboratory instruments and machines. LAUDA thermostats are, naturally, also used in our own measuring instruments. For example, in order to determine the viscosity of aviation fuel under real conditions at 10,000-meter altitude, the sample is cooled down to -45 °C in the laboratory.

Through numerous innovations and ongoing investment, LAUDA is sustainably improving its excellent market position and is growing both in the main European market as well as overseas.

LAUDA – The right temperature worldwide



Finest thermostat technology: The new LAUDA ECO sets new standards in its class



ECO RE 1050 G

With the new ECO, LAUDA is continuing the unique success story of the current LAUDA Ecoline equipment range. Innovations and developments have taken place above all in terms of performance and user friendliness. The two control heads, called ECO Silver and ECO Gold, have an even more powerful circulating pump with six power levels, a maximum pressure of 0.55 bar and

a pump flow of up to 22 L/min. A USB interface comes as standard with both. Other interfaces such as analogue, contact, RS 232/485 and profibus modules can be positioned individually in the available slots. The connection of a Pt100 probe with the new Pt100/LiBus module makes both ECO Gold and ECO Silver suitable for exact external control. Furthermore the Command remote control known from Proline and Integral XT can be used. Another innovation is a practical pump flow distribution at the front on the control head. As such, the pump flow can be distributed individually between internal and external circulation even during operation.

The thermostats with a Silver control head offer a monochrome LCD and a programmer with one program and 20 segments. These are suited for temperatures up to 150 °C. Users who choose a unit with a Gold control head receive the equipment features of a coloured TFT display, a comprehensive programmer with 150 temperature-time segments distributed over five programs, an integrated ramp function and timer switch, plus a temperature profile display. The maximum temperature is 200 °C. ECO cooling thermostats are available as air-cooled and water-cooled variants.

LAUDA Integral XT: Air-cooled process thermostat down to -80 °C



Integral XT 280 W

LAUDA is extending the equipment range of process thermostats with an additional model - the Integral XT 280. It is the first air-cooled device in the ultra-low temperature range within the product line Integral. The XT 280 works in the temperature range from -80 up to 200 °C. With a cooling capacity of 1.5 kW (at 20 °C) and a heater power of 4 kW rapid temperature changes for external applications are possible.

LAUDA Proline Kryomats: High cooling capacities at low temperatures and with large baths



Proline Kryomat RP 4090 CW

In the ultra-low temperature range for external and primarily internal applications, with the Proline Kryomats, LAUDA is offering eight new devices all fitted with the removable Command remote control as a standard feature. Impressive: the high cooling capacity particularly at low temperatures. Water-cooled and air-cooled variants with bath volumes of 30 and 40 liters are available in the temperature range from -90 up to 200 °C or -50 up to 200 °C.



Adaptive control: Saves time and improves temperature regulation

Now as a standard feature for no extra charge on all LAUDA cooling and process thermostats with a Command remote control. This automatically calculates the optimum control parameters for different applications. Time-consuming searching is eliminated. Retrofitting is simple: connect the Command remote control to a PC and execute a setup.exe file – and that is it! The file is available free of charge in the download area at www.lauda.de.

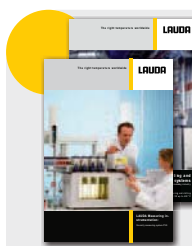

Ask for more information about LAUDA measuring instruments and LAUDA heating and cooling systems free of charge. This and additional information can be found in the download area at: www.lauda.de

LAUDA – Much more than temperature control equipment

The right temperature worldwide and the greatest precision – at LAUDA, these claims also extend to include extremely high performance Heating and Cooling systems and intelligent Measuring instruments.

LAUDA Measuring Instruments

Viscometers and tensiometers from LAUDA are essential for the analysis of polymers, oils, greases and tensides. With the modular concept of the PVS process viscometer, measuring routines can be conducted effectively, quickly and safely and repeated as desired. The LAUDA iVisc capillary viscometer is new, space-saving, fully automatic and easy to operate. With LAUDA tensiometers, it is possible for example to determine the exact interfacial surface tension of transformer oils. Countless measuring instruments have long been used in the food and beverage industry, in petrochemistry, by tenside manufacturers and in pharmacy.



LAUDA Heating and Cooling systems



In accordance with the principle of “modular engineering”, LAUDA process cooling systems, heat transfer systems and secondary circuit systems are planned and built precisely according to customer's wishes: process-oriented, customized and with precision control, meeting the strictest safety standards. Within a temperature range of -150 up to 400 °C, LAUDA systems heat and cool to accuracy of one tenth of a degree Celsius. As the requirements for temperature regulation systems are constantly increasing, the modern LAUDA heating and cooling modules are flexibly extendable and modifiable. The combination of planning, production, our own test bay and a comprehensive service package makes LAUDA heating and cooling systems a valued partner around the world.

Subsidiaries

Our subsidiary and representative in North America.

Toronto, Canada

2

Delran, New Jersey

1

- LAUDA headquarters in Germany
- Worldwide subsidiaries

LAUDA-Brinkmann, LP



LAUDA America Latina C.A.



● LAUDA DR. R. WOBSE GMBH & CO. KG

LAUDA France S.A.R.L.



● OOO „LAUDA Wostok“



LAUDA China Co., Ltd.



LAUDA Singapore Pte. Ltd.



LAUDA. The right temperature worldwide. Our subsidiary and representative in North America.

1 **LAUDA-Brinkmann, LP**
Constant temperature equipment,
Measuring instrumentation,
Service
1819 Underwood Boulevard
08075 Delran, NJ
USA
North America
Phone: +1 856 764 7300
Fax: +1 856 764 7307
E-mail: info@lauda-brinkmann.com
Internet: <http://www.lauda-brinkmann.com>

2 **Brinkmann Instruments (Canada) Corp.**
Constant temperature equipment,
Measuring instrumentation,
Service
4160 Sladeview Crescent #6
L5L0A1 Mississauga,
Ontario
Canada
Phone: +1 905-569-0664
Fax: +1 905-569-0665
E-mail: info@brinkmanncanada.com
Internet: <http://www.brinkmanncanada.com/home/>

LAUDA cooperates with more than 100 representatives around the world. Thoroughly trained and highly qualified employees in sales and service of our representatives give friendly and competent advice to our customers worldwide. Please refer to **www.lauda.de** for detailed contact data of your local LAUDA representative (sector: Company → Worldwide).

LAUDA Aqualine

The universal water baths for the laboratory
from 25 up to 95 °C



Application examples

- Preparation of medical samples for analysis
- Temperature control of cytological samples
- Pre-thermostating of samples for spectroscopic tests
- Use in colleges and education

Reliable, compact and ergonomic

The **LAUDA Aqualine** water baths offer an affordable entry into laboratory thermostating. The equipment range for basic applications in the laboratory stands out for its simple operation with digital LED display and high reliability. The devices have no circulating pumps and no

fittings within the bath. Consequently, they are corrosion-resistant, easy to clean or disinfect, and provide maximum use of internal bath space. The heating elements housed under the bath vessel ensure homogenous temperature distribution without localised overheating.

Your advantages at a glance



The Aqualine advantages

Your benefits

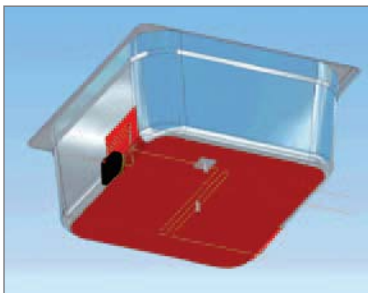

- Heating of the bath bottom across the entire base
- Patented low-level protection, minimum fill level of only 2 cm

- Excellent temperature homogeneity in the bath and optimum use of the internal space
- Bath operation almost independent of the fill level



- Recessed operating elements
- Luminous digital LED display
- Controller electronics integrated into the housing

- Dirt and drip-proof electronics
- Easy operation
- Smallest possible unit footprint



- No heaters, sensors or other fittings in the bath vessel

- Easy-clean interior
- No niches for hidden growth of germs
- Full use of the bath

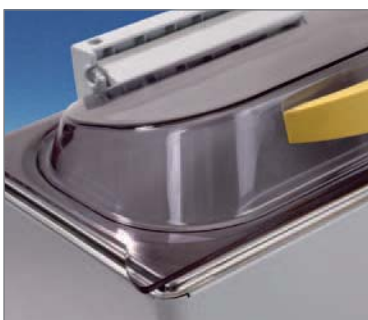

- Transparent polycarbonate gable covers removable without tools are a standard feature
- Optimised roof shape

- Easy and quick visual inspection of the samples in the bath
- Easy cleaning, no height restrictions
- Prevents sample contamination from condensation

LAUDA Aqualine

Aqualine Water baths

The LAUDA Aqualine water baths are available in five different sizes. Depending on the size and the quantity of the samples, the user has the right bath depth or opening for his application at his disposal. All the baths are made from moulded stainless steel, and do not have any fittings. As a result, the interior is used to its full advantage, and the number of samples per bath is maximised. Above all, the LAUDA Aqualine is designed for the requirements of biological, medical and biochemical laboratories. Thanks to the patented heating concept, the baths also achieve a high level of temperature homogeneity.



Heating curves Heat transfer liquid: Water, bath closed

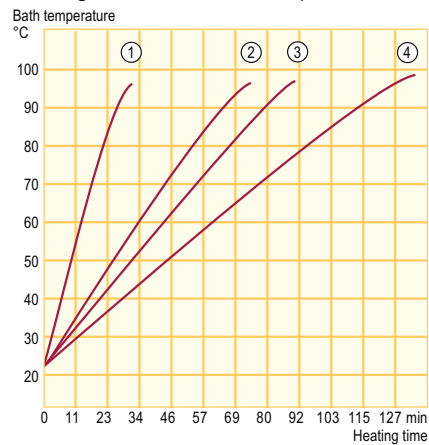

- ① AL 2
- ② AL 5 · AL 12
- ③ AL 18
- ④ AL 25

Temperature range

25...95 °C

Standard accessories

Transparent polycarbonate gable cover



AL 5 water bath



All technical data from page 88
Other power supply variants on page 98

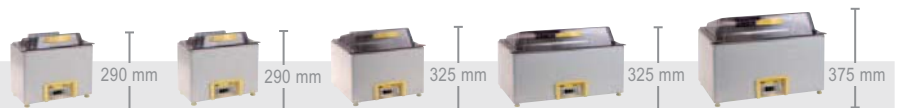

Technical features		AL 2	AL 5	AL 12	AL 18	AL 25
Working temperature range	°C	25...95	25...95	25...95	25...95	25...95
Temperature stability at 37 °C	±K	0.2	0.2	0.2	0.2	0.2
Heater power	kW	0.45	0.45	1.0	1.2	1.2
Bath volume	L	0.9...1.7	1...5	2...12	3...18	3...25
Bath opening/Bath depth	mm	300x151/65	300x151/150	329x300/150	505x300/150	505x300/200
Cat. No.	115 V; 60 Hz	LCB 4723	LCB 4724	LCB 4725	LCB 4726	LCB 4727

Aqualine accessories

Test tube racks

Polypropylene up to 95 °C

Cat.-No.:	Description	Qty. Tubes	Ø mm
UE 041	rack white	21	30
UE 040	rack white	24	25
UE 039	rack white	40	20
UE 042	rack white	60	16
UE 037	rack white	90	13
UE 047	rack yellow	21	30
UE 046	rack yellow	24	25
UE 045	rack yellow	40	20
UE 048	rack yellow	60	16
UE 043	rack yellow	90	13
suitable for	1 x in AL 5 2 x in AL 12 4 x in AL 18, AL 25		



Test tube rack

Stainless steel up to 150 °C

Cat.-No.:	Description	Qty. Tubes	Ø mm
UE 038	test tube rack stainless steel	12	20
suitable for	1 x in AL 5 3 x in AL 12 6 x in AL 18, AL 25		

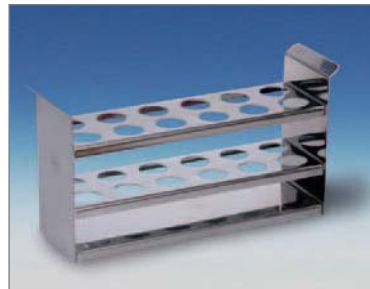

Platform

Stainless steel up to 100 °C, with eight height adjustable steps

Cat.-No.:	Usable area mm
LCZ 0689	140x270
suitable for	1 x in AL 12 2 x in AL 18, AL 25



Order the detailed LAUDA accessories brochure and the heat transfer liquids brochure free of charge. This and additional product information can also be found at www.lauda.de

LAUDA Alpha

Heating and cooling thermostats for cost-effective thermostating in the laboratory at temperatures from -25 up to 85 °C



Application examples

- Sample preparation for chemico-pharmaceutical analysis
- Quality control
- Precise temperature control in sensitive areas such as medical serology
- Versatile thermostating tasks in the field of biotechnology

Reliable technology, modern design, favorable price

LAUDA Alpha is the cost-effective choice in the area of high-quality LAUDA thermostats. The temperature range from -25 to 85 °C covers the larger part of all basic thermostatic applications within the laboratory. This is exactly the working temperature range of the new LAUDA Alpha. This well-priced equipment range is made pos-

sible by minimizing any unnecessary features, with the focus on reliability and user-friendliness. The thermostats are suitable for operation with non-flammable liquids (water, water/glycol) and for both internal and external thermostating tasks. A 1-point-calibration of the thermostats can be carried out by the user.

Your advantages at a glance



The Alpha advantages

Your benefits



- 3-button operation with large, clearly legible LED display

- Easy and intuitive menu navigation
- Easily legible display values



- Automatic compressor control supplies strong cooling output only when needed – up to 425 W

- Cost-effective operation
- No unnecessary energy consumption
- Equipment-saving principle extends the life of the compressor



- Alpha immersion and heating thermostats with screw clamp

- Easy to change to different bath vessels with a wall thickness of up to 25 mm



- Variable flow rates via inserts and fittings

- The rate of circulation can be adapted to the size of the bath



- Removal of the front cover without tools

- Easy cleaning of the cool air inlet
- Extended maintenance intervals

LAUDA Alpha

Alpha Immersion thermostat

The immersion thermostat A can be used for any bath with a wall thickness of up to 25 mm by means of the screw clamp included in the scope of delivery. Using the optional pump circulation set and a cooling coil, the immersion thermostat can be expanded to form a full-fledged thermostating system.



Immersion thermostat A



Pump characteristic Heat transfer liquid: Water

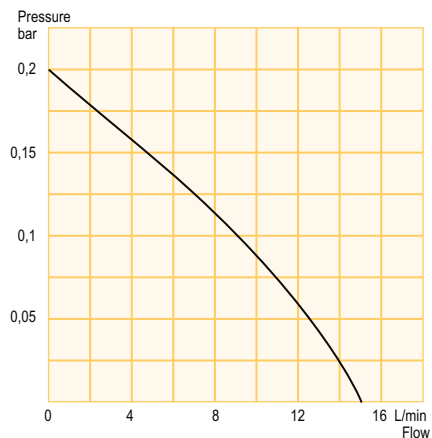

Temperature range

25...85 °C

Standard accessories

Screw clamp · pump reduction in 2 sizes

Recommended accessories see p. 19

Pump circulation set · cooling coil



All technical data from page 88
Other power supply variants on page 98



Technical features		A
Working temperature range	°C	25...85
Temperature stability	±K	0.05
Heater power	kW	1.15
Pump pressure max.	bar	0.2
Pump flow max.*	L/min	15
Cat. No. 115 V; 60 Hz		LCEX 4226

* Reducible to 5 L/min

Alpha Heating thermostats

The heating thermostats A 6, A 12 and A 24 operate in the temperature range between 25 and 85 °C. As in the case of the immersion thermostats, a cooling coil and pump circulation set as well as a bath cover set are available as optional accessories.



Heating thermostat A 12 with accessory cooling coil



Heating curves Heat transfer liquid: Water

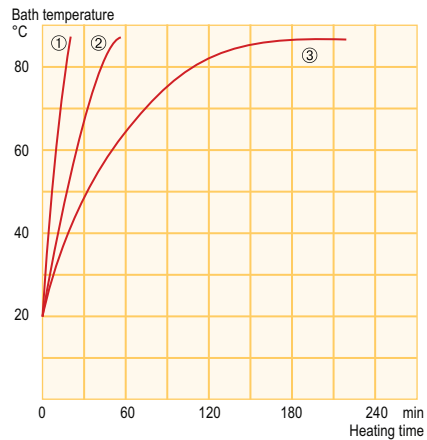

- ① A 6
- ② A 12
- ③ A 24

Temperature range
25...85 °C

Standard accessories
Screw clamp · pump reduction in 2 sizes

Recommended accessories see p. 19
Pump circulation set · cooling coil · bath cover set



All technical data from page 88
Other power supply variants on page 98



Technical features		A 6	A 12	A 24
Working temperature range	°C	25...85	25...85	25...85
Temperature stability	±K	0.05	0.05	0.05
Heater power	kW	1.15	1.15	1.15
Pump pressure max.	bar	0.2	0.2	0.2
Pump flow max.	L/min	15	15	15
Bath volume	L	2.5...5.5	8...12	18...25
Bath opening	mm	145x161	235x161	295x374
Bath depth	mm	150	200	200
Cat. No.	115 V; 60 Hz	LCBX 4733	LCBX 4734	LCBX 4735

LAUDA Alpha

Alpha Cooling thermostats

The cooling technology of the cooling thermostats RA 8, RA 12 and RA 24 enables cooling performance through the entire temperature range of -25 up to 85 °C. A drain connection on the rear side of the devices makes emptying the heat transfer liquid a simple job. Bath covers and pump kits are included in the standard equipment.



Cooling thermostat RA 24



Cooling curves Heat transfer liquid: Ethanol

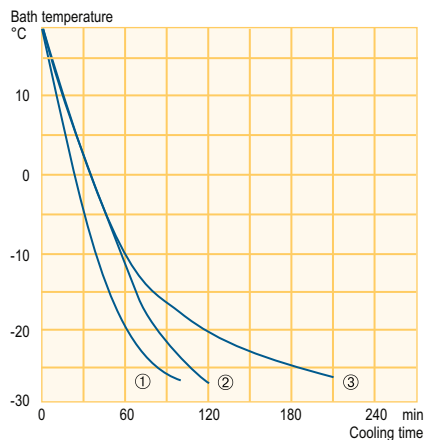

- ① RA 8
- ② RA 12
- ③ RA 24

Temperature range

-25...85 °C

Standard accessories

Pump circulation set · bath cover · pump link for pump connections

Recommended accessories

Racks · tubings

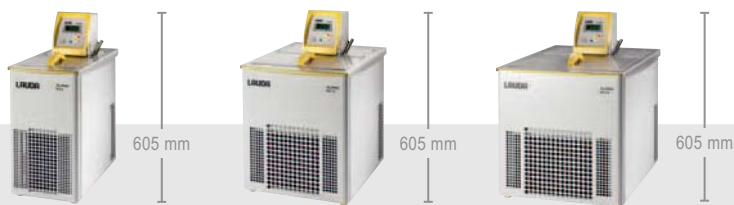

All technical data from page 92
Other power supply variants on page 99

Technical features		RA 8	RA 12	RA 24
Working temperature range*	°C	-25...85	-25...85	-25...85
Temperature stability	±K	0.05	0.05	0.05
Heater power	kW	1.15	1.15	1.15
Cooling output at 20 °C	kW	0.225	0.325	0.425
Pump pressure max.	bar	0.2	0.2	0.2
Pump flow max.	L/min	15	15	15
Bath volume	L	5...7.5	9.5...14.5	14...22
Bath opening	mm	165x190	300x190	350x290
Bath depth	mm	160	160	160
Cat. No.		LCKX 4907	LCKX 4908	LCKX 4909

* Working temperature range is equal to ACC range

Alpha accessories

Pump circulation set

For thermostating of external applications

Cat.-No.:	Description
LCZE 005	Pump circulation set
For all Alpha immersion and heating thermostats	

Cooling coil

For additional cooling of heating baths by means of cold water

Cat.-No.:	Description
LCZE 004	Cooling coil
For all Alpha immersion and heating thermostats	

Test tube racks

Polypropylene up to 95 °C*

Cat.-No.:	Description	Qty. Tubes	Ø mm
UE 047/UE 041	rack yellow/white	21	30
UE 046/UE 040	rack yellow/white	24	25
UE 045/UE 039	rack yellow/white	40	20
UE 048/UE 042	rack yellow/white	60	16
UE 043/UE 037	rack yellow/white	90	13
suitable for	3 x A 24 2 x RA 12 3 x RA 24		

* Test tube rack stainless steel up to 150 °C available on request

Bath cover sets

For assembly on LAUDA Alpha heating baths.
Consisting of bath bridge, bath cover, 2 blanking plates and 4 screws

Cat.-No.:	Designation
LCZE 006	Bath cover set A 6
LCZE 007	Bath cover set A 12
LCZE 008	Bath cover set A 24

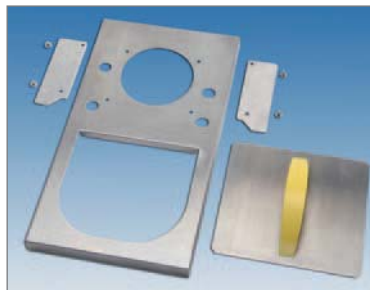

Order the detailed LAUDA accessories brochure and the heat transfer liquids brochure free of charge. This and additional product information can also be found at www.lauda.de

LAUDA ECO

NEW

Heating and cooling thermostats
Economical thermostating in the laboratory
from -50 up to 200 °C



Application examples

- Precise temperature regulation in quality assurance and analytics
- Sample preparation in chemistry and pharmacy
- Temperature control in electronics and life sciences
- Cooling in material tests

Precise, economical, flexible

With the new ECO LAUDA is continuing the amazing success story of the current equipment series, the LAUDA Ecoline. There are innovations and developments particularly with regard to the range of features and the ease of operation. Both control heads, designated ECO Silver and ECO Gold, have a powerful circulating pump with a more than 30 percent higher pump capacity compared to the predecessor models. A menu navigation in plain text allows easy operation of the devices. Both control heads are equipped with a mini-USB

interface as standard. Further interfaces are available as modules. Another innovation is the practical allocation of a flow rate switch at the front on the control head. This means that individual adjustment of the flow between internal and external circulation is possible even during operation. The angular front is unique and minimises the footprint. The most powerful units are equipped with the energy-saving LAUDA SmartCool system. All cooling thermostats are available as air-cooled or water-cooled variants.

Your advantages at a glance



The ECO advantages

Your benefits



- Menu navigation via monochrome LCD (Silver) or colored TFT display (Gold)
- Programmer with both models

- Easy and clear operation
- Parameters are clearly readable
- Automation of temperature variations and test series



- Cooling capacities of 180, 200, 300 and 700 W and minimal temperatures from -15 up to -50 °C
- All cooling thermostats available as air-cooled and water-cooled versions
- Energy-saving SmartCool System with 700 W cooling capacity

- Application related temperature control
- Choice of models regarding ambient conditions
- Energy and cost savings with digital cooling management



- Strong circulation pump with six levels; flow rate switch placed at the front of the control head for internal or external circulation
- Pump connections as standard with cooling thermostats
- Cooling coil as standard with heating thermostats

- Adaptation of pump power to applications and different bath sizes
- Convenient working even at ambient temperature, without additional cooling
- Temperature control of external applications
- Connection of cooling water or external cooling for work below ambient temperature



- Mini-USB interface as standard
- Upper module slot: Analogue, RS 232/485, contact or Profibus module, to insert as an accessory
- Lower module slot: Pt100/LiBus module as accessory

- Computer connection and easy software updates
- Provides user with flexible control options
- Precise control of external applications
- Command remote control via LiBus



- Drain valves standard on all heating and cooling thermostats with stainless steel baths at the back of the devices

- Easy and safe changing of heat transfer liquids

LAUDA ECO

ECO Control head Silver

The control heads Silver with 1.3 kW heater power (115 V and 230 V) are perfectly suited for thermostating tasks up to 150 °C. They are fitted with a monochrome LCD display.



ECO Control head Gold

The control heads Gold with a heating power of 2,6 kW (230 V) have a working temperature range of up to 200 °C. They are provided with a larger colored TFT display. Temperature profiles can be displayed graphically. A comprehensive programmer with five programmes and 150 temperature-time segments, a ramp function and a clock timer are further distinctive features compared to Silver.



Silver

- 1.3 kW heater power (115 V and 230 V), working temperature range up to 150 °C
- LCD display, resolution of indication 0.01 °C
- Operation via cursor and softkeys
- Simultaneous display of set and actual temperature, navigation in plain text
- Overtemperature setting via display
- Safety class III, FL for flammable liquids
- 1-point calibration by the user
- Programmer with one program and 20 segments
- Vario pump with six levels, flow rate switch for internal or external circulation
- Mini-USB interface as standard



Gold

- 2.6 kW heater power (230 V), working temperature range up to 200 °C
- Colored TFT display, resolution of indication 0.01 °C
- Operation via cursor and softkeys
- Simultaneous display of set and actual temperature, navigation in plain text
- Overtemperature setting via display
- Safety class III, FL for flammable liquids
- 1-point calibration by the user
- Graphical display of temperature profiles
- Ramp function, clock timer
- Programmer with five programs and 150 segments
- Vario pump with six levels, flow rate switch for internal or external circulation
- Mini-USB interface as standard

ECO Immersion thermostats

The immersion thermostats ECO can be used for any bath with a wall thickness of up to 25 mm and a bath depth of at least 150 mm by means of the screw clamp included in the scope of delivery.



Immersion thermostat Gold



Pump characteristics Heat transfer liquid: Water

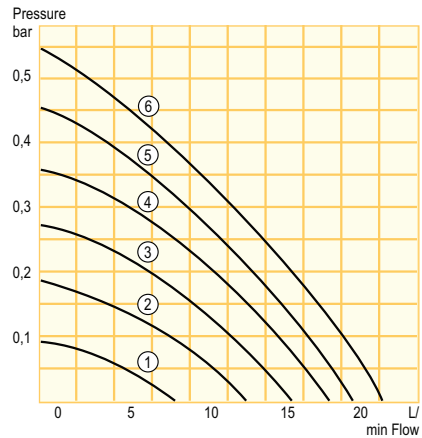

- ① Step 1
- ② Step 2
- ③ Step 3
- ④ Step 4
- ⑤ Step 5
- ⑥ Step 6

Temperature range

Silver: 20...150 °C
Gold: 20...200 °C

Standard accessories

Screw clamp

Recommended accessories

Baths · cooling coil · pump connection set · Optional modules: analogue, RS 232/485, contact, Profibus, Pt100/LiBus module



325 mm



325 mm



All technical data from page 88
Other power supply variants on page 98

Technical features		Silver	Gold
Working temperature range	°C	20...150	20...200
Temperature stability	±K	0.01	0.01
Heater power 115 V/220 V	kW	1.3/1.2	1.3/2.4
Pump pressure max.	bar	0.55	0.55
Pump flow max.	L/min	22	22
Bath depth	mm	min. 150	min. 150
Cat. No. 115 V; 60 Hz		LCE 4227	LCE 4228
Cat. No. 220 V; 60 Hz		LCE 2227	LCE 2228

LAUDA ECO

ECO Cooling thermostats with stainless steel bath and control head Silver

The cooling thermostats with control head Silver are available in the temperature range from -50 up to 150 °C. They are equipped with a bath cover and pump connections for external applications as standard. The pump connections are nipples made of high-quality plastic with an outer diameter of 13 mm. The RE 415 S is the basic model with minimised foot print. The RE 1050 S with SmartCool digital cooling management can be used down to -50 °C and provides a cooling capacity of 700 W at 20 °C. Thanks to the larger baths, both models RE 1225 S and RE 2025 S are excellently suited to applications inside the bath.



Cooling thermostat RE 415 S



Cooling curves Heat transfer liquid: Ethanol, bath closed

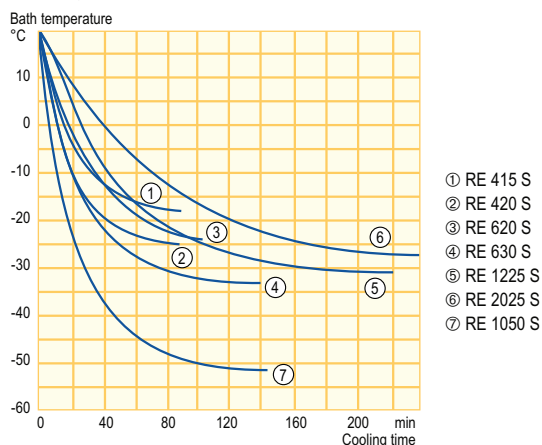

Pump characteristics on page 23

Temperature range
-50...150 °C

Standard accessories

Bath cover · pump connections with 13 mm plastic nipples · closing plugs

Recommended accessories

Hoses · Optional module: analogue, RS 232/485, contact, Profibus, Pt100/LiBus module · Command remote control



All technical data from page 92
Other power supply variants on page 99



Technical features		RE 415 S	RE 420 S	RE 620 S	RE 630 S	RE 1050 S	RE 1225 S	RE 2025 S
Working temperature range	°C	-15...150	-20...150	-20...150	-30...150	-50...150	-25...150	-25...150
Temperature stability	±K	0.02	0.02	0.02	0.02	0.02	0.02	0.02
Heater power 115 V/220 V	kW	1.3/1.2	1.3/1.2	1.3/1.2	1.3/1.2	1.3/1.2	1.3/1.2	1.3/1.2
Cooling output at 20 °C	kW	0.18	0.2	0.2	0.3	0.7	0.3	0.3
Pump pressure max.	bar	0.55	0.55	0.55	0.55	0.55	0.55	0.55
Pump flow max.	L/min	22	22	22	22	22	22	22
Bath volume	L	3.3...4	3.3...4	4.6...5.7	4.6...5.7	8...10	9.3...12	14...20
Bath opening/depth	mm	130x105/160	130x105/160	150x130/160	150x130/160	200x200/160	200x200/200	300x350/160
Cat. No. 115 V; 60 Hz		LCK 4910	LCK 4912	LCK 4914	LCK 4916	LCK 4918	LCK 4920	LCK 4922
Cat. No. 220 V; 60 Hz		LCK 2910	LCK 2912	LCK 2914	LCK 2916	LCK 2918	LCK 2920	LCK 2922

ECO Cooling thermostats with stainless steel bath and control head Gold

The cooling thermostats with control head Gold work up to 200 °C. Included as standard is a bath cover and pump connections made of stainless steel with M16x1 threads. The RE 1050 G has an especially high cooling capacity and reaches temperatures down to -50 °C. The integrated SmartCool system ensures remarkable energy and cost savings. The RE 415 G with small foot print saves valuable laboratory space.



Cooling thermostat RE 1050 G



Cooling curves Heat transfer liquid: Ethanol, bath closed

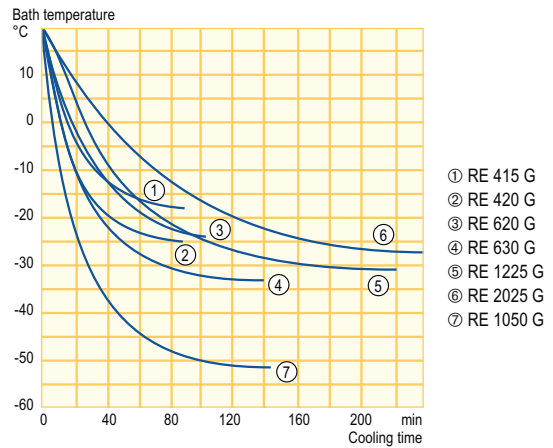

Pump characteristics on page 23

Temperature range
-50...200 °C

Standard accessories

Bath cover · pump connections with M16x1 thread · closing plugs

Recommended accessories

Hoses · Optional modules: analogue, RS 232/485, contact, Profibus, Pt100/LiBus module · Command remote control



All technical data from page 92
Other power supply variants on page 99



Technical features		RE 415 G	RE 420 G	RE 620 G	RE 630 G	RE 1050 G	RE 1225 G	RE 2025 G
Working temperature range*	°C	-15...200	-20...200	-20...200	-30...200	-50...200	-25...200	-25...200
Temperature stability	±K	0.02	0.02	0.02	0.02	0.02	0.02	0.02
Heater power 115 V/220 V	kW	1.3/2.4	1.3/2.4	1.3/2.4	1.3/2.4	1.3/2.4	1.3/2.4	1.3/2.4
Cooling output at 20 °C	kW	0.18	0.2	0.2	0.3	0.7	0.3	0.3
Pump pressure max.	bar	0.55	0.55	0.55	0.55	0.55	0.55	0.55
Pump flow max.	L/min	22	22	22	22	22	22	22
Bath volume	L	3.3...4	3.3...4	4.6...5.7	4.6...5.7	8...10	9.3...12	14...20
Bath opening/depth	mm	130x105/160	130x105/160	150x130/160	150x130/160	200x200/160	200x200/200	300x350/160
Cat. No. 115 V; 60 Hz	-	LCK 4911	LCK 4913	LCK 4915	LCK 4917	LCK 4919	LCK 4921	LCK 4923
Cat. No. 220 V; 60 Hz	-	LCK 2911	LCK 2913	LCK 2915	LCK 2917	LCK 2919	LCK 2921	LCK 2923

* Working temperature range is equal to ACC range

LAUDA ECO

ECO Water-cooled cooling thermostats with stainless steel bath and control head Silver and Gold

The cooling thermostats with control heads Silver and Gold are also available as water-cooled models. By discharging process heat to the cooling water, heating-up of the environment will be reduced. This is an advantage when using several devices or when working at high ambient temperatures.



Cooling thermostat RE 1050 GW



Cooling curves Heat transfer liquid: Ethanol, bath closed

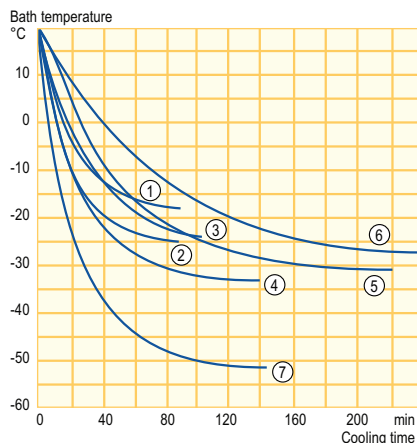

- ① RE 415 SW
RE 415 GW
- ② RE 420 SW
RE 420 GW
- ③ RE 620 SW
RE 620 GW
- ④ RE 630 SW
RE 630 GW
- ⑤ RE 1225 SW
RE 1225 GW
- ⑥ RE 2025 SW
RE 2025 GW
- ⑦ RE 1050 SW
RE 1050 GW

Pump characteristics on page 23

Temperature range

Silver: -50...150 °C

Gold: -50...200 °C

Standard accessories

Bath cover · pump connections with 13 mm plastic nipples (Silver) or M16x1 thread (Gold) and 13 mm nipples · closing plugs

Recommended accessories

Hoses · Optional modules: analogue, RS 232/485, contact, Profibus, Pt100/LiBus module · Command remote control



All technical data from page 92

Other power supply variants on page 99

Technical features		RE 415 SW	RE 420 SW	RE 620 SW	RE 630 SW	RE 1050 SW	RE 1225 SW	RE 2025 SW
Working temperature range*	°C	-15...150	-20...150	-20...150	-30...150	-50...150	-25...150	-25...150
Temperature stability	±K	0.02	0.02	0.02	0.02	0.02	0.02	0.02
Heater power 115 V/220 V	kW	1.3/1.2	1.3/1.2	1.3/1.2	1.3/1.2	1.3/1.2	1.3/1.2	1.3/1.2
Cooling output at 20 °C	kW	0.18	0.2	0.2	0.3	0.7	0.3	0.3
Pump pressure max.	bar	0.55	0.55	0.55	0.55	0.55	0.55	0.55
Pump flow max.	L/min	22	22	22	22	22	22	22
Bath volume	L	3.3...4	3.3...4	4.6...5.7	4.6...5.7	8...10	9.3...12	14...20
Bath opening/depth	mm	130x105/160	130x105/160	150x130/160	150x130/160	200x200/160	200x200/200	300x350/160
Cat. No. 115 V; 60 Hz		LCK 4924	LCK 4926	LCK 4928	LCK 4930	LCK 4932	LCK 4934	LCK 4936
Cat. No. 220 V; 60 Hz		LCK 2924	LCK 2926	LCK 2928	LCK 2930	LCK 2932	LCK 2934	LCK 2936

Technical features		RE 415 GW	RE 420 GW	RE 620 GW	RE 630 GW	RE 1050 GW	RE 1225 GW	RE 2025 GW
Working temperature range*	°C	-15...200	-20...200	-20...200	-30...200	-50...200	-25...200	-25...200
Temperature stability	±K	0.02	0.02	0.02	0.02	0.02	0.02	0.02
Heater power 115 V/220 V	kW	1.3/2.4	1.3/2.4	1.3/2.4	1.3/2.4	1.3/2.4	1.3/2.4	1.3/2.4
Cooling output at 20 °C	kW	0.18	0.2	0.2	0.3	0.7	0.3	0.3
Pump pressure max.	bar	0.55	0.55	0.55	0.55	0.55	0.55	0.55
Pump flow max.	L/min	22	22	22	22	22	22	22
Bath volume	L	3.3...4	3.3...4	4.6...5.7	4.6...5.7	8...10	9.3...12	14...20
Bath opening/depth	mm	130x105/160	130x105/160	150x130/160	150x130/160	200x200/160	200x200/200	300x350/160
Cat. No. 115 V; 60 Hz		LCK 4925	LCK 4927	LCK 4929	LCK 4931	LCK 4933	LCK 4935	LCK 4937
Cat. No. 220 V; 60 Hz		LCK 2925	LCK 2927	LCK 2929	LCK 2931	LCK 2933	LCK 2935	LCK 2937

* Working temperature range is equal to ACC range

ECO

Heating thermostats with transparent bath and control head Silver and Gold

LAUDA ECO units with transparent plastic baths provide the necessary visibility in all cases where test samples need to be observed during thermostating. The thermostats with baths made from polycarbonate can be used in the temperature range of up to 100 °C. They have a filling volume of 5 up to 20 liters. All devices except the ET 15 S and ET 15 G are equipped with a cooling coil as standard.



Heating thermostat ET 12 S



Heating curves Heat transfer liquid: Water, bath closed

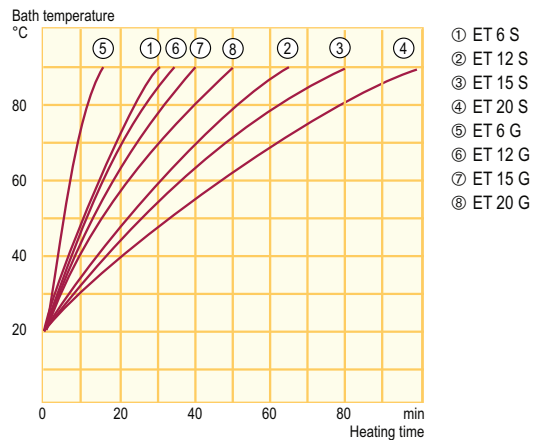

Pump characteristics on page 23

Temperature range

20...100 °C

Standard accessories

Cooling coil (not with ET 15 S and ET 15 G) · pump connections with 13 mm plastic nipples (ET 15 S) or M16x1 thread (ET 15 G) · closing plugs

Recommended accessories

Hoses · cover plates (only ET 15 S · ET 15 G) · Optional modules: analogue, RS 232/485, contact, Profibus, Pt100/LiBus module · Command remote control



All technical data from page 88

Other power supply variants on page 98

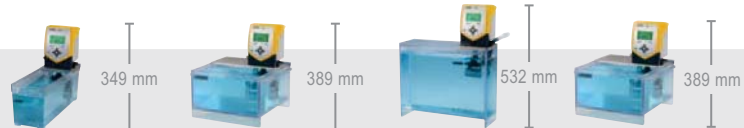

Technical features		ET 6 S	ET 12 S	ET 15 S	ET 20 S
Working temperature range	°C	20...100	20...100	20...100	20...100
Temperature stability	±K	0.01	0.01	0.01	0.01
Heater power 115 V/220 V	kW	1.3/1.2	1.3/1.2	1.3/1.2	1.3/1.2
Pump pressure max.	bar	0.55	0.55	0.55	0.55
Pump flow max.	L/min	22	22	22	22
Bath volume	L	5...6	9.5...12	13.5...15	15...20
Bath opening/depth	mm	130x285/160	300x175/160	275x130/310	300x350/160
Cat. No. 115 V; 60 Hz		LCM 4096	LCD 4286	LCD 4288	LCD 4290
Cat. No. 220 V; 60 Hz		LCM 2096	LCD 2286	LCD 2288	LCD 2290

Technical features		ET 6 G	ET 12 G	ET 15 G	ET 20 G
Working temperature range	°C	20...100	20...100	20...100	20...100
Temperature stability	±K	0.01	0.01	0.01	0.01
Heater power 115 V/220 V	kW	1.3/2.4	1.3/2.4	1.3/2.4	1.3/2.4
Pump pressure max.	bar	0.55	0.55	0.55	0.55
Pump flow max.	L/min	22	22	22	22
Bath volume	L	5...6	9.5...12	13.5...15	15...20
Bath opening/depth	mm	130x285/160	300x175/160	275x130/310	300x350/160
Cat. No. 115 V; 60 Hz		LCM 4097	LCD 4287	LCD 4289	LCD 4291
Cat. No. 220 V; 60 Hz		LCM 2097	LCD 2287	LCD 2289	LCD 2291

LAUDA ECO

ECO Heating thermostats with stainless steel bath and control head Silver

The heating thermostats with control head Silver are suitable for a temperature range of up to 150 °C. All heating thermostats are equipped with a cooling coil as standard. The E 4 S is fitted with a bath cover and pump connections for external applications with nipples made from plastic.



Heating thermostat E 4 S



Heating curves Heat transfer liquid: Therm 240, bath closed

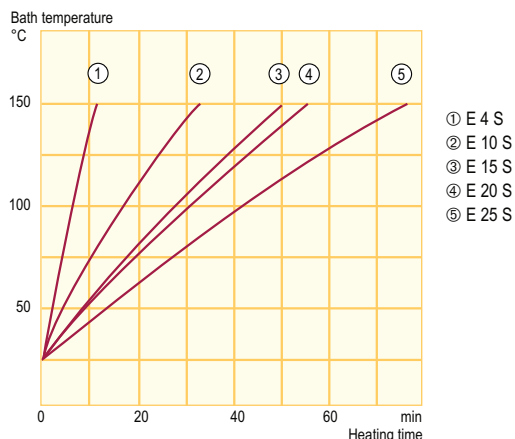

- ① E 4 S
- ② E 10 S
- ③ E 15 S
- ④ E 20 S
- ⑤ E 25 S

Pump characteristics on page 23

Temperature range

20...150 °C

Standard accessories

Cooling coil · bath cover and pump connections with 13 mm plastic nipples and closing plugs (E 4 S only)

Recommended accessories

Hoses · bath covers · pump circulation set ·
Optional modules: analogue, RS 232/485, contact, Profibus, Pt100/LiBus module · Command remote control



All technical data from page 88
Other power supply variants on page 98



Technical features		E 4 S	E 10 S	E 15 S	E 20 S	E 25 S	E 40 S
Working temperature range	°C	20...150	20...150	20...150	20...150	20...150	20...150
Temperature stability	±K	0.01	0.01	0.01	0.01	0.01	0.01
Heater power 115 V/220 V	kW	1.3/1.2	1.3/1.2	1.3/1.2	1.3/1.2	1.3/1.2	1.3/1.2
Pump pressure max.	bar	0.55	0.55	0.55	0.55	0.55	0.55
Pump flow max.	L/min	22	22	22	22	22	22
Bath volume	L	3...3.5	7.5...11	12...16	13...19	16...25	32...40
Bath opening/depth	mm	135x105/150	300x190/150	300x190/200	300x365/150	300x365/200	300x613/200
Cat. No. 115 V; 60 Hz		LCB 4736	LCB 4738	LCB 4740	LCB 4742	LCB 4744	LCB 4746
Cat. No. 220 V; 60 Hz		LCB 2736	LCB 2738	LCB 2740	LCB 2742	LCB 2744	LCB 2746

ECO Heating thermostats with stainless steel bath and control head Gold

The heating thermostats with control head Gold can be used in a temperature range of up to 200 °C. All heating thermostats are equipped with a cooling coil as standard. The E 4 G is fitted with a bath cover and pump connections for external applications with M16x1 threads.



Heating thermostat E 20 G



Heating curves Heat transfer liquid: Therm 240, bath closed

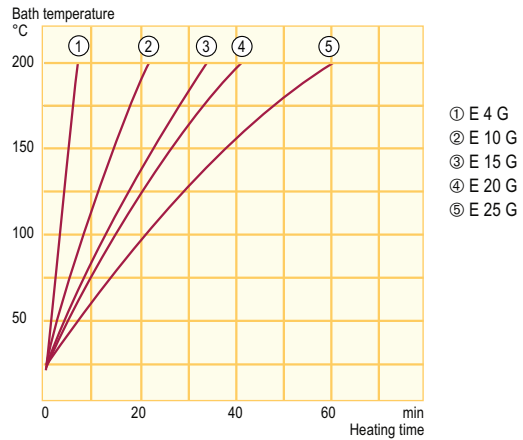

Pump characteristics on page 23

Temperature range
20...200 °C

Standard accessories

Cooling coil · bath cover and pump connection set with 16x1 thread (E 4 G only)

Recommended accessories

Hoses · bath covers · pump circulation set ·
Optional modules: analogue, RS 232/485, contact, Profibus, Pt100/LiBus module · Command remote control



All technical data from page 88

Other power supply variants on page 98



Technical features		E 4 G	E 10 G	E 15 G	E 20 G	E 25 G	E 40 G
Working temperature range	°C	20...200	20...200	20...200	20...200	20...200	20...200
Temperature stability	±K	0.01	0.01	0.01	0.01	0.01	0.01
Heater power 115 V/220 V	kW	1.3/2.4	1.3/2.4	1.3/2.4	1.3/2.4	1.3/2.4	1.3/2.4
Pump pressure max.	bar	0.55	0.55	0.55	0.55	0.55	0.55
Pump flow max.	L/min	22	22	22	22	22	22
Bath volume	L	3...3.5	7.5...11	12...16	13...19	16...25	32...40
Bath opening/depth	mm	135x105/150	300x190/150	300x190/200	300x365/150	300x365/200	300x613/200
Cat. No. 115 V; 60 Hz		LCB 4737	LCB 4739	LCB 4741	LCB 4743	LCB 4745	LCB 4747
Cat. No. 220 V; 60 Hz		LCB 2737	LCB 2739	LCB 2741	LCB 2743	LCB 2745	LCB 2747

LAUDA ECO

ECO baths

There is a variety of different baths made of high-quality polycarbonate and deep-drawn stainless steel for immersion thermostats. For viewing the objects subjected to thermostating we offer four different transparent baths with a max. volume of 6 to 20 liters. They are made of polycarbonate

and can be used up to 100 °C. The insulated stainless steel baths have a max. volume from 3.5 to 40 liters and can be used up to 200 °C. All stainless steel baths have a convenient built-in drain tap at the back site. The exterior is made from durable, powder-coated sheet steel.



Transparent baths up to 100 °C		6 T	12 T	15 T	20 T
Material		polycarbonate	polycarbonate	polycarbonate	polycarbonate
Temperature max.	°C	100	100	100	100
Volume max.	L	6	12	15	20
Int. dimensions (WxDxH)	mm	130x420x160	300x315x160	416x130x310	300x490x160
Cat. No.		LCZ 0703	LCZ 0704	LCZ 0705	LCZ 0706

Stainless steel baths up to 200 °C		B 4	B 10	B 15	B 20	B 25	B 40
Material		stainless steel	stainless steel	stainless steel	stainless steel	stainless steel	stainless steel
Temperature max.	°C	200	200	200	200	200	200
Volume max.	L	3,5	11	16	19	25	40
Int. dimensions (WxDxH)	mm	135x240x150	300x329x150	300x329x200	300x505x150	300x505x200	300x750x200
Cat. No.		LCZ 0707	LCZ 0708	LCZ 0709	LCZ 0710	LCZ 0711	LCZ 0712

ECO accessories

Cooling coil sets

For cooling of any heating baths

Cat. No.	Designation	suitable for
LCZ 0720	Cooling coil set small	ECO Silver, ECO Gold, Baths up to 6 liter
LCZ 0721	Cooling coil set large	ECO Silver, ECO Gold, Baths from 6 liter

Bath cover

Cat. No.	Designation	suitable for
HDQ 133	Bath cover, stainless steel	E 10 S/G, E 15 S/G
HDQ 134	Bath cover, stainless steel	E 20 S/G, E 25 S/G
LCZ 0718	Bath cover, stainless steel	E 40 S/G (three pieces)

Pump connection sets

For thermostating of external applications. Both pump connection sets are usable with ECO Silver and ECO Gold.

Cat. No.	Designation
LCZ 0716	with 13 mm plastic nipples
LCZ 0717	with M16x1 stainless steel connections, screw caps and 13 mm nipples

Optional modules

Cat. No.	Designation	suitable for
LRZ 912	Analogue module	upper module slot
LRZ 913	RS 232/485 interface	upper module slot
LRZ 914	Contact module with 1 input and 1 output	upper module slot
LRZ 915	Contact module with 3 inputs and 3 outputs	upper module slot
LRZ 917	Profibus module	upper module slot
LRZ 918	Pt100/LiBus module	lower module slot

Command remote controle

with RS 232/485 interface as standard

Cat. No.	Designation
LRT 914	Command remote control with graphic LCD display for remote control via LiBus. Only possible in combination with Pt100/LiBus module (LRZ 918)



Order the detailed LAUDA accessories brochure and the heat transfer liquids brochure free of charge. This and additional product information can also be found at www.lauda.de

LAUDA Proline

Heating and cooling thermostats with temperatures from -90 up to 300 °C for professional use in research, application engineering and production



Proline

Application examples

- Temperature control for chemical synthesis
- Tests on electronic components at different temperatures
- Temperature control of measuring structures in process technology
- Heating and cooling of glass reactors

Proline Kryomats

Application examples

- Constant temperatures in the notch bending test and drop test
- Changing temperatures when determining the pour point, Brookfield test of lubricants and test of slide bearings

Intuitive operation, ultra high and low temperatures

LAUDA Proline thermostats are our solution for high performance and reliable temperature regulation. With their broad temperature range they fulfill high requirements. LAUDA Proline thermostats are available in two versions: in the basic version with the Master control head, and as a Command version with a removable

control unit for enhanced ease of operation. Master version devices can be retrofitted with the Command remote control, which are simply connected to the control head. The thermostat automatically recognises and controls all newly installed moduls.

Your advantages at a glance



The Proline advantages

Your benefits



- Master or Command version
- 52 different devices
- Simple retrofitting from Master to Command version

- The right solution for every application
- Subsequent extension or adaptation to changing application requirements



- Graphical user guidance
- Adaptive control on cooling thermostats

- Easy and intuitive operation
- Saves time-consuming calculation of control parameters

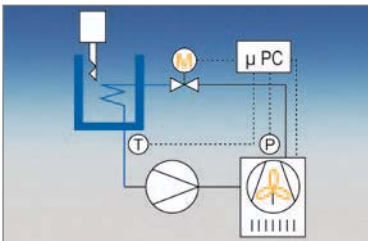

- Patented SmartCool system
- PowerAdapt system for adjustment of the power consumption

- Up to 75 percent energy saving with digital cooling management
- Use of the maximum available output from the power supply system



- Two insert ports can be combined with five different interface modules
- Easy distribution of the pump flow by means of bypass valve
- Pump connections on the side and rear

- High level of flexibility for the user allowing for broad range of system integration
- Simultaneous connection of two external applications
- Flexible connection of external applications from different sides



- High-performance pressure-suction-pump (Varioflex pump) with eight pump levels
- Up to 3.5 kW (230 V) heating power – even on all cooling thermostats via SmartCool system

- Suitable for internal and external applications
- Adaptation of the pump power to the respective application and bath size
- Rapid heating achieved

LAUDA Proline

Proline Master control head

The Proline Master devices are designed with high thermostating accuracy and reliability for all applications from -90 up to 300 °C where operating parameters are not changed or modified frequently. They have all the basic features and safety functions required for professional thermostating during continuous use. A modular structure and bus technology have created an instrument capable of extending its function and performance as the application requires.

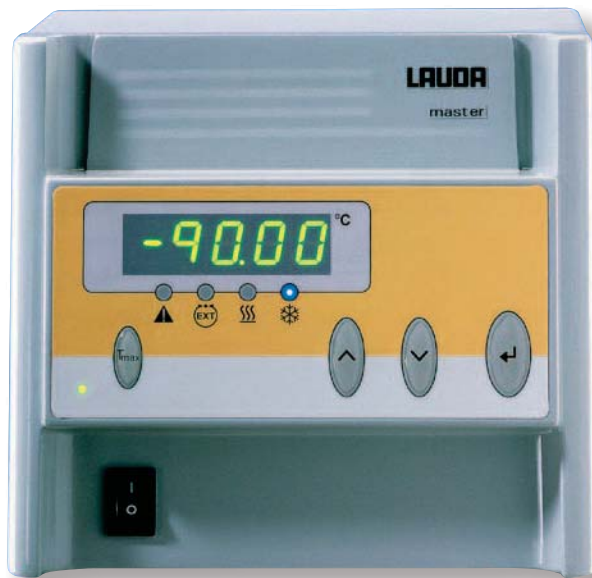

- Easy-to-read green LED display
- Convenient setting of set-temperature and Varioflex pump via three operation buttons
- Indicator lights for heating, cooling, external control and alarm
- Resolution of indication 0.01 °C, setting resolution selectable 0.1 or 0.01 °C
- Selectable operating temperature range and additional button for overtemperature protection
- External temperature control via Pt 100
- Optical and audible alarm function
- Simple temperature probe calibration
- Integrated mains network safety device
- Start mode control (automatic or manual)
- Two slots for LiBus modules
- LAUDA Wintherm Plus control software via RS 232/485 interface (optional)



Easy replacement of interface modules

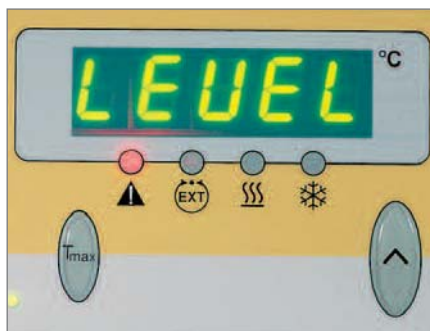

Alarm message for malfunction



Upgradable to Command version

Proline Command control head

The Command control heads are the top models of the LAUDA Proline. The highly-efficient programmer fulfills all the requirements of complex thermostating processes – with real-time function. It offers the utmost in user-friendliness and optimum functionality, e.g. for an industrial testing lab. The simple menu-driven operation and the easy editing of test programs allow for quickly changing thermostating tasks. The Command console is removable and can easily be used as a remote control (with cable). Comprehensive basic equipment as with the Proline Master range.



Basic equipment as Proline Master, plus:

- 10-key console for setpoint adjustment of temperature
- Programmer with real-time clock, 150 temperature/time segments, for use in up to 5 programs, editable segments with loop and tolerance band function
- High resolution, back-lit, graphic LCD display with various display possibilities
- Detachable Command console for use as a remote control (up to 50 m)
- Eight freely selectable fixed temperatures with memory function
- Resolution of actual value display up to 0.001 °C
- RS 232/485 interface for LAUDA Wintherm Plus software
- Menu guidance in German, English, French and Spanish



An opto-decoupled RS 232/485 interface is integrated as standard

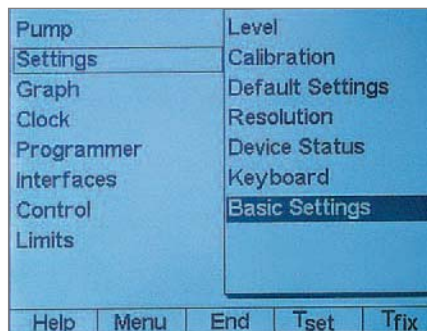

Drop-down menus make settings easy. Available in four languages.

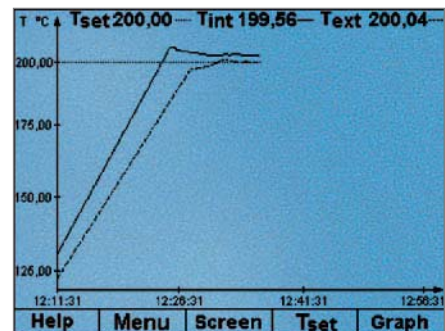

Graphic display of temperature values

LAUDA Proline

Proline Heating thermostats with Master control head up to 19 liters

The heating thermostats of the LAUDA Proline with Master control head do not only shine because of their compact construction. The high heater power of 3.5 kW (230 V), two interfaces for various modules, a cooling coil fitted as a standard feature, and an integrated external control – these features make them particularly useful for users who require flexible thermostating operations while only rarely needing to adjust the settings.



Heating thermostat P 18



Pump characteristics Heat transfer liquid: Water

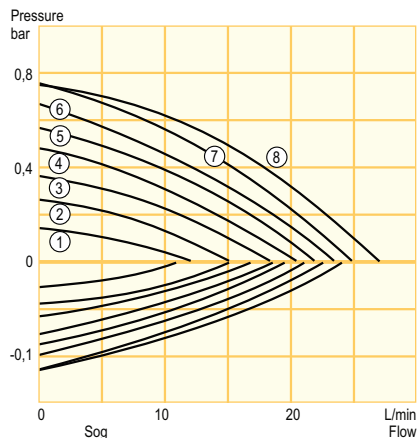

- ① Step 1
- ② Step 2
- ③ Step 3
- ④ Step 4
- ⑤ Step 5
- ⑥ Step 6
- ⑦ Step 7
- ⑧ Step 8

Temperature range

30...300 °C

Standard accessories

Bath cover · 2 nipples and 4 closing plugs for pump connections · 2 nipples for cooling coil

Recommended accessories

Constant level device (for P 8) · automatic filling device · through-flow cooler · reverse flow protection · tubes · solenoid valve for cooling water control · high-temperature cooler (water) · Optional modules: analogue, RS 232/485, contact, Profibus module



All technical data from page 90
Other power supply variants on page 98



Technical features		P 5	P 8	P 12	P 18
Working temperature range	°C	35...300	35...300	30...300	30...300
Temperature stability	±K	0.01	0.01	0.01	0.01
Heater power 115 V/208-220 V	kW	1.8/3.5	1.8/3.5	1.8/3.5	1.8/3.5
Pump pressure max.	bar	0.7	0.7	1.1*	0.7
Pump suction max.	bar	0.4	0.4	-	0.4
Pump flow (pressure) max.	L/min	25	25	32*	25
Pump flow (suction) max.	L/min	23	23	-	23
Bath volume	L	3.5...5.5	5.5...8	6.5...13.5	12.5...19
Bath opening/Bath depth	mm	150x50/200	150x150/200	150x150/320	300x200/200
Cat. No. 115 V; 60 Hz		LCB 4708	LCB 4710	LCB 4716**	LCB 4712
Cat. No. 208-220 V; 60 Hz		LCB 8708	LCB 8710	LCB 8716**	LCB 8712

* Pressure pump only, pump characteristics see page 40

** Instead of pressure and suction pump: Varioflex pump featured on P 12 model with increased output

Proline Heating thermostats with Master control head up to 53 liters

The LAUDA Proline P 26, P 40 and P 50 heating thermostats are distinguished by particularly large-volume baths. All the below models are equipped with a Varioflex pump and cover the temperature range from 30 up to 300 °C. These stainless steel baths are ideally suited to direct thermostating inside the bath. The P 40 is particularly suitable for thermostating applications needing a large submersion depth. The P 26 and P 50 models with their wide baths, allow long or bulky test pieces to be placed in the bath or even enable a number of test pieces to be positioned alongside each other, for simultaneous testing.

A circulation chamber on the P 40 and P 50 ensures good mixing in the bath and thus guarantees good temperature homogeneity, despite the large bath vessel.



Heating thermostat P 50



Heating curves Heat transfer liquid: Ultra 300, bath closed

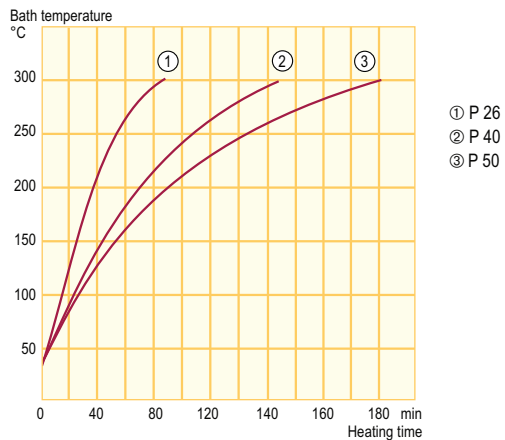

Temperature range
30...300 °C

Standard accessories

Bath cover (only P 26) · 2 nipples and 4 closing plugs for pump connections · 2 nipples for cooling coil

Recommended accessories

Bath cover · automatic filling device · through-flow cooler · reverse flow protection · tubes · solenoid valve for cooling water control · high-temperature cooler (water) · rising platform (for P 40) · Optional modules: analogue, RS 232/485, contact, Profibus module



All technical data from page 90
Other power supply variants on page 98



Technical features		P 26	P 40	P 50
Working temperature range	°C	30...300	35...300*	30...300*
Temperature stability	±K	0.01	0.01	0.01
Heater power 115 V/208-220 V	kW	1.8/3.5	-/3.5	-/3.5
Pump pressure max.	bar	0.7	0.7	0.7
Pump suction max.	bar	0.4	0.4	0.4
Pump flow (pressure) max.	L/min	25	25	25
Pump flow (suction) max.	L/min	23	23	23
Bath volume	L	18...27	30...37	35...53
Bath opening/Bath depth	mm	300x350/200	250x250/450	300x750/200
Cat. No. 115 V; 60 Hz		LCB 4714	-	-
Cat. No. 208-220 V; 60 Hz		LCB 8714	LCB 8728	LCB 8730

* Max. temperature only achieved with closed bath cover

LAUDA Proline

Proline Heating thermostats with Command control head up to 19 liters

The Proline heating thermostats with Command control head (C) impress through an expanded scope of functions. Alongside a graphic LCD display, which enables current values to be displayed up to 0.001 °C resolution, an easily editable and convenient programmer with storage possibilities is available. The standard RS 232/485 interface enables communication with a computer. Work flexibly with Command: The Command remote control can be quickly and easily detached from the thermostat.



Heating thermostat P 18 C



Heating curves Heat transfer liquid: Ultra 300, bath closed

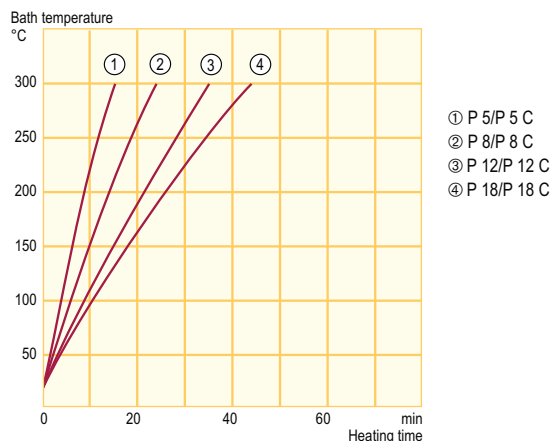

Temperature range
30...300 °C

Standard accessories

Bath cover · 2 nipples and 4 closing plugs for pump connections · 2 nipples for cooling coil

Recommended accessories

Constant level device (for P 8 C) · automatic filling device · through-flow cooler · reverse flow protection · tubes · solenoid valve for cooling water control · high-temperature cooler (water) · Optional modules: analogue, RS 232/485, contact, Profibus module



All technical data from page 90
Other power supply variants on page 98



Technical features		P 5 C	P 8 C	P 12 C	P 18 C
Working temperature range	°C	35...300	35...300	30...300	30...300
Temperature stability	±K	0.01	0.01	0.01	0.01
Heater power 115 V/208-220 V	kW	1.8/3.5	1.8/3.5	1.8/3.5	1.8/3.5
Pump pressure max.	bar	0.7	0.7	1.1*	0.7
Pump suction max.	bar	0.4	0.4	-	0.4
Pump flow (pressure) max.	L/min	25	25	32*	25
Pump flow (suction) max.	L/min	23	23	-	23
Bath volume	L	3.5...5.5	5.5...8	6.5...13.5	12.5...19
Bath opening/Bath depth	mm	150x50/200	150x150/200	150x150/320	300x200/200
Cat. No. 115 V; 60 Hz		LCB 4709	LCB 4711	LCB 4717**	LCB 4713
Cat. No. 208-220 V; 60 Hz		LCB 8709	LCB 8711	LCB 8717**	LCB 8713

* Pressure pump only. Pump characteristics see page 40

** Instead of pressure and suction pump: Varioflex pump featured on P 12 model with increased output

Proline Heating thermostats with Command control head up to 53 liters

In order to enhance ease of use even further, P 26 C, P 40 C and P 50 C heating thermostats with large baths are also available with the Command control head which allows complex thermostating functions, particularly those with internal thermostating processes, to be easily mastered with the aid of an intuitive operation guidance system and the ability to edit programs rapidly.

A circulation chamber on the P 40 and P 50 ensures good mixing in the bath and thus guarantees good temperature homogeneity, despite the large bath vessel.



Heating thermostat P 40 C



Heating curves Heat transfer liquid: Ultra 300, bath closed

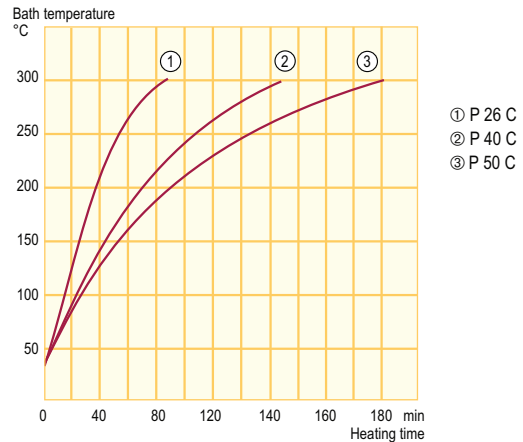

Temperature range
30...300 °C

Standard accessories

Bath cover (only P 26 C) · 2 nipples and 4 closing plugs for pump connections · 2 nipples for cooling coil

Recommended accessories

Automatic filling device · bath cover · through-flow cooler · reverse flow protection · tubes · solenoid valve for cooling water control · high-temperature cooler (water) · rising platform (for P 40) · Optional modules: analogue, RS 232/485, contact, Profibus module



All technical data from page 90
Other power supply variants on page 98

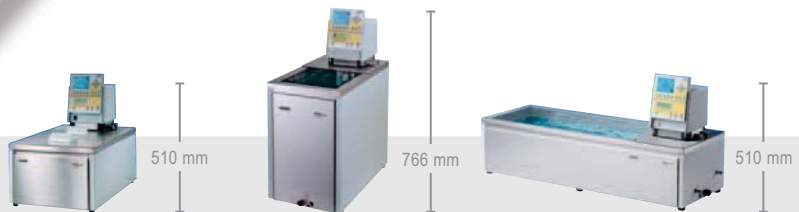

Technical features		P 26 C	P 40 C	P 50 C
Working temperature range	°C	30...300	30...300*	30...300*
Temperature stability	±K	0.01	0.01	0.01
Heater power 115 V/208-220 V	kW	1.8/3.5	-/3.5	-/3.5
Pump pressure max.	bar	0.7	0.7	0.7
Pump suction max.	bar	0.4	0.4	0.4
Pump flow (pressure) max.	L/min	25	25	25
Pump flow (suction) max.	L/min	23	23	23
Bath volume	L	18...27	30...37	35...53
Bath opening/Bath depth	mm	300x350/200	250x250/450	300x750/200
Cat. No. 115 V; 60 Hz		LCB 4715	-	-
Cat. No. 208-220 V; 60 Hz		LCB 8715	LCB 8729	LCB 8731

* Max. temperature achieved only with closed bath cover

LAUDA Proline

Proline Clear-view thermostats

LAUDA Proline clear-view thermostats for the direct observation of the samples: the PVL models come equipped with five layers of insulating glass and are suitable for low temperatures down to -60 °C. This makes them ideal for the use with the fully-automatic LAUDA PVS viscosity measuring system. The two-chamber principle in the measuring area ensures a constant level, irrespective of the loading and the temperature. The connection of a through-flow cooler or Proline RP 890 enables low temperature measurements down to -40 °C/-60 °C.



LAUDA PVS 1/4 viscosity measuring system with PV 24 clear-view thermostat
– Stands not included in scope of delivery –



All technical data from page 90
Other power supply variants on page 98



Pump characteristics Heat transfer liquid: Water

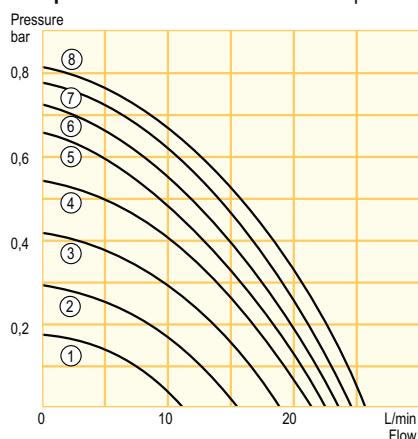

- ① Step 1
- ② Step 2
- ③ Step 3
- ④ Step 4
- ⑤ Step 5
- ⑥ Step 6
- ⑦ Step 7
- ⑧ Step 8

Heating curves Heat transfer liquid: Therm 240, bath closed

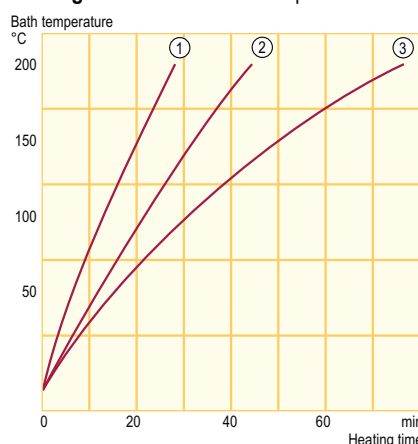

- ① PV 15 (up to 230 °C)
PVL 15 (up to 100 °C)
- ③ PV 24 (up to 230 °C)
PVL 24 (up to 100 °C)
- ③ PV 36

Temperature range
30...230 °C

Standard accessories

- 2 nipples and 4 closing plugs for pump connections ·
- 2 nipples for cooling coil

Recommended accessories

- Window heating system · solenoid valve for cooling water

Technical features		PV 15/PV 15 C	PV 24/PV 24 C	PV 36/PV 36 C	PVL 15/PVL 15 C	PVL 24/PVL 24 C
Working temperature range	°C	30...230	30...230	30...230	30...100	30...100
Operating temperature range	°C	0*...230	0*...230	0*...230	-60**...100	-60**...100
Temperature stability	±K	0.01	0.01	0.01	0.01	0.01
Heater power 115 V/208-220 V	kW	1.8/-	-/3.5	-/3.5	1.8/-	1.8/-
Pump pressure max.	bar	0.8	0.8	0.8	0.8	0.8
Pump suction max.	bar	-	-	-	-	-
Pump flow (pressure) max.	L/min	25	25	25	25	25
Pump flow (suction) max.	L/min	-	-	-	-	-
Bath volume	L	11...15	19...24	28...36	11...15	19...24
Bath opening/Bath depth	mm	230x135/320	405x135/320	585x135/320	230x135/320	405x135/320
Size of glass panel	mm	149x230	326x230	506x230	149x230	326x230
Cat. No. Master 115 V; 60 Hz		LCD 4276	-	-	LCD 4282	LCD 4284
Cat. No. Master 208-220 V; 60 Hz		-	LCD 8278	LCD 8280	-	-
Cat. No. Command 115 V; 60 Hz		LCD 4277	-	-	LCD 4283	LCD 4285
Cat. No. Command 208-220 V; 60 Hz		-	LCD 8279	LCD 8281	-	-

* Only achievable with LAUDA add-on cooler

** Only achievable with LAUDA Proline RP 890

Proline Bridge thermostats

LAUDA Proline bridge thermostats are available in two versions with different pump models and immersion depths. The PB models have a pressure/suction pump and require a bath depth of 200 mm, while the PBD models have a more powerful pressure pump (D) and thermostat baths with a depth from 320 mm. In addition, both series of models differ in the selected control head: Master or Command (C). Through variably extendable telescopic rods, all models can be attached without problem to baths with a width of 310 mm up to 550 mm.



Bridge thermostat PBD C
– Bath not included in scope of delivery –

Pump characteristics for PB and PBC, Heat transfer liquid: Water

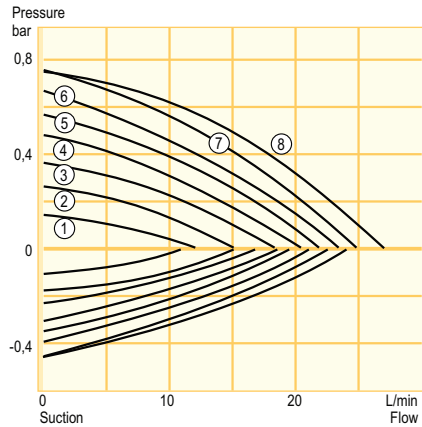

- ① Step 1
- ② Step 2
- ③ Step 3
- ④ Step 4
- ⑤ Step 5
- ⑥ Step 6
- ⑦ Step 7
- ⑧ Step 8

Pump characteristics for PBD and PBD C P 12 and P 12 C, Heat transfer liquid: Water

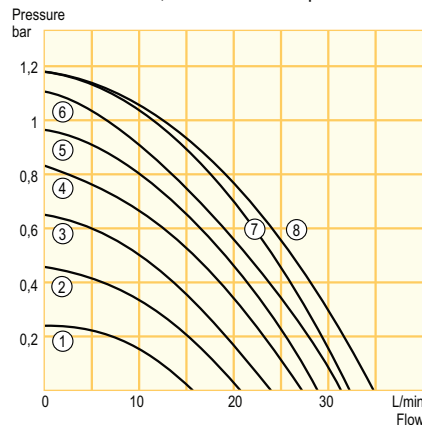

- ① Step 1
- ② Step 2
- ③ Step 3
- ④ Step 4
- ⑤ Step 5
- ⑥ Step 6
- ⑦ Step 7
- ⑧ Step 8

Temperature range
30...300 °C

Standard accessories

2 nipples and 4 closing plugs for pump connections · telescopic rods

Recommended accessories

Through-flow cooler · automatic filling device · water bath
Optional modules: analogue, RS 232/485, contact, Profibus module



All technical data from page 90
Other power supply variants on page 99

Technical features		PB/PB C	PBD/PBD C
Working temperature range	°C	30...300	30...300
Temperature stability	±K	0.01	0.01
Heater power	kW	1.8	1.8
Pump pressure max.	bar	0.7	1.1
Pump suction max.	bar	0.4	–
Pump flow (pressure) max.	L/min	25	32
Pump flow (suction) max.	L/min	23	–
Bath volume up to approx.	L	80	80
Bath opening	mm	telescopic rods can be extended for bath widths 310...550	
Bath depth min.	mm	200	320
Cat. No. Master 115 V; 60 Hz		LCG 4090	LCG 4092
Cat. No. Command 115 V; 60 Hz		LCG 4091	LCG 4093

LAUDA Proline

Proline Cooling thermostats with Master control head up to 8 liters

The Proline RP 845, RP 855, RP 870 and RP 890 cooling thermostats stand out above all for their compact dimensions and small footprint. With a cooling capacity of 1.6 kW at 20 °C, the RP 855 has a particularly high-performance design. The RP 890 low-temperature device enables you to reach temperatures down to -90 °C. The standard integrated bath bridge heating prevents ice build up as a result of condensation and humidity on all Proline cooling thermostats with a temperature range down to -90 °C.



Cooling thermostat RP 845



Cooling curves Heat transfer liquid: Ethanol, bath closed

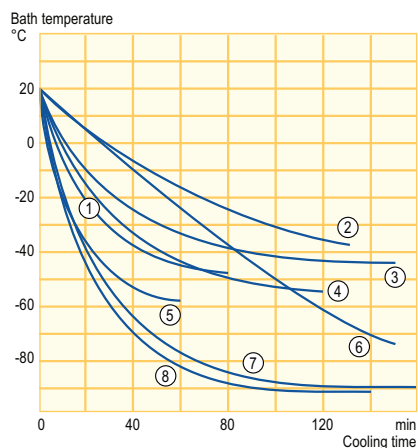

- ① RP 845
- ② RP 3530
- ③ RP 1840
- ④ RP 1845
- ⑤ RP 855
- ⑥ RP 870
- ⑦ RP 1290
- ⑧ RP 890

Temperature range

-90...200 °C

Standard accessories

Bath cover · 2 nipples and 4 closing plugs for pump connections · bath bridge heating for RP 890

Recommended accessories

Constant level device for RP 845 and RP 855 · reverse flow protection · automatic filling device · tubes · Option: bath bridge heating for RP 855 and RP 870 · Optional modules: analogue, RS 232/485, contact, Profibus module · set of castors for RP 890



All technical data from page 92
Other power supply variants on page 100

Technical features		RP 845	RP 855	RP 870	RP 890
Working temperature range*	°C	-45...200	-55...200	-70...200	-90...200
Temperature stability	±K	0.01	0.01	0.02	0.02
Heater power 115 V/208-220 V	kW	1.8/2.9	-/2.9	-/2.9	-/2.9
Cooling output at 20 °C	kW	0.8	1.6	0.38	1.1
Pump pressure max.	bar	0.7	0.7	0.7	0.7
Pump suction max.	bar	0.4	0.4	0.4	0.4
Pump flow (pressure) max.	L/min	25	25	25	25
Pump flow (suction) max	L/min	23	23	23	23
Bath volume	L	5.5...8	5.5...8	5.5...8	5.5...8
Bath opening/depth	mm	150x150/200	150x150/200	150x150/200	150x150/200
Cat. No. 115 V; 60 Hz		LCK 4885	-	-	-
Cat. No. 208-220 V; 60 Hz		LCK 8885	LCK 8893	LCK 8895	LCK 8897

* Working temperature range is equal to ACC range

Proline Cooling thermostats with Master control head up to 35 liters

The Proline RP 1290, RP 1840, RP 1845 and RP 3530 cooling thermostats differ in terms of bath volume, achievable cooling capacity, and working temperature range. With bath capacities up to 35 liters, the RP 3530 provides a particularly large bath volume and the RP 1845 provides a particularly high cooling capacity of 1.6 kW.



Cooling thermostat RP 1845



Heating curves Heat transfer liquid: Ultra 300, bath closed

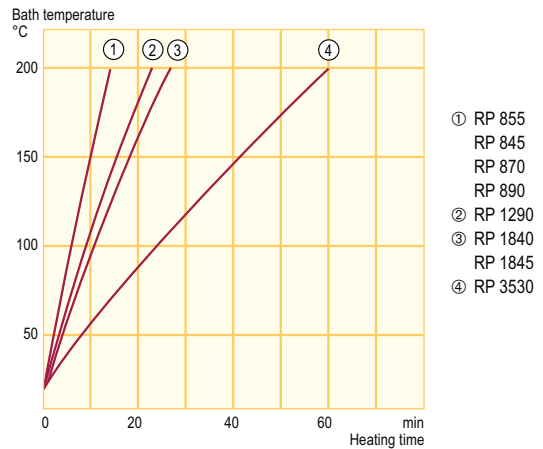

- ① RP 855
RP 845
RP 870
RP 890
- ② RP 1290
- ③ RP 1840
RP 1845
- ④ RP 3530

Temperature range
-88...200 °C

Standard accessories

Bath cover · 2 nipples and 4 closing plugs for pump connections · bath bridge heating for RP 1290

Recommended accessories

Reverse flow protection · automatic filling device · tubes ·
Optional modules: analogue, RS 232/485, contact, Profibus module · set of castors for RP 1290



All technical data from page 92
Other power supply variants on page 100



Technical features		RP 1290	RP 1840	RP 1845	RP 3530
Working temperature range*	°C	-88...200	-40...200	-50...200	-35...200
Temperature stability	±K	0.02	0.01	0.01	0.02
Heater power 115 V/208-220 V	kW	-/2.9	1.75/2.9	-/2.9	1.75/2.9
Cooling output at 20 °C	kW	1.1	0.9	1.6	0.9
Pump pressure max.	bar	0.7	0.7	0.7	0.7
Pump suction max.	bar	0.4	0.4	0.4	0.4
Pump flow (pressure) max.	L/min	25	25	25	25
Pump flow (suction) max	L/min	23	23	23	23
Bath volume	L	15...17.5	12.5...19	12.5...19	23...35
Bath opening/depth	mm	300x150/200	300x200/200	300x200/200	300x350/250
Cat. No. 115 V; 60 Hz		-	LCK 4887	-	LCK 4889
Cat. No. 208-220 V; 60 Hz		LCK 8899	LCK 8887	LCK 8891	LCK 8889

* Working temperature range is equal to ACC range

LAUDA Proline

Proline Cooling thermostats with Command control head up to 8 liters

The SmartCool system – an energy-saving, digital cooling management system – ensures that every temperature is run with the correct cooling capacity. It increases or reduces the cooling according to application requirements. The advantages are particularly effective for programmer operation and temperature ramping.

The Proline cooling thermostats with the Command control head (C) have a convincing extended range of functions. At 20 °C, RP 855 C has a particularly high cooling capacity of 1.6 kW. RP 890 C and RP 1290 C are designed for especially low temperatures. They differ in terms of bath volume and have bath bridge heating as a standard feature.



Cooling thermostat RP 845 C



Cooling curves Heat transfer liquid: Ethanol, bath closed

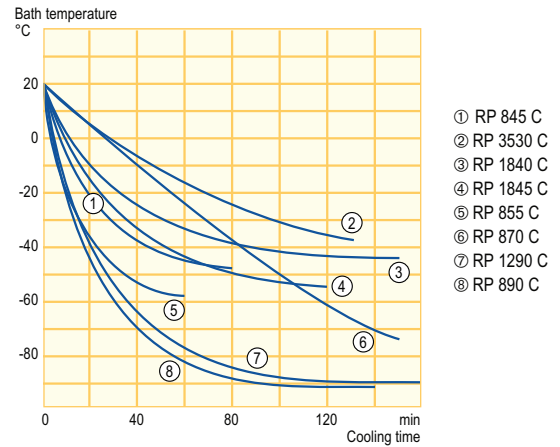

Temperature range

-90...200 °C

Standard accessories

Bath cover · 2 nipples and 4 closing plugs for pump connections · bath bridge heating for RP 890 C

Recommended accessories

Constant level device for RP 845 C und RP 855 C · reverse flow protection · automatic filling device · tubes · Option: bath bridge heating for RP 855 C and RP 870 C · Optional modules: analogue, RS 232/485, contact, Profibus module · set of castors for RP 890 C



All technical data from page 92
Other power supply variants on page 100

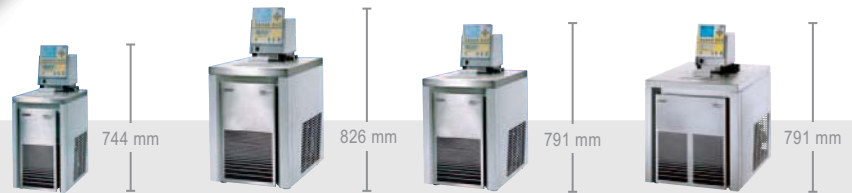

Technical features		RP 845 C	RP 855 C	RP 870 C	RP 890 C
Working temperature range*	°C	-45...200	-55...200	-70...200	-90...200
Temperature stability	±K	0.01	0.01	0.02	0.02
Heater power 115 V/208-220 V	kW	1.75/2.9	-/2.9	-/2.9	-/2.9
Cooling output at 20 °C	kW	0.8	1.6	0.38	1.1
Pump pressure max.	bar	0.7	0.7	0.7	0.7
Pump suction max.	bar	0.4	0.4	0.4	0.4
Pump flow (pressure) max.	L/min	25	25	25	25
Pump flow (suction) max.	L/min	23	23	23	23
Bath volume	L	5.5...8	5.5...8	5.5...8	5.5...8
Bath opening/depth	mm	150x150/200	150x150/200	150x150/200	150x150/200
Cat. No. 115 V; 60 Hz		LCK 4886	-	-	-
Cat. No. 208-220 V; 60 Hz		LCK 8886	LCK 8894	LCK 8896	LCK 8898

* Working temperature range is equal to ACC range

Proline Cooling thermostats with Command control head up to 35 liters

Thanks to their various capacity ranges and filling volumes, the Proline cooling thermostats which make up the Command range skilfully adapt to your requirements. The RP 1845 C works at a temperature range between -50 and 200 °C and, at 20 °C, has a cooling capacity of 1.6 kW. The RP 3530 C has a particularly large bath for internal sample thermostating.



Cooling thermostat RP 1840 C



Heating curves Heat transfer liquid: Ultra 300, bath closed

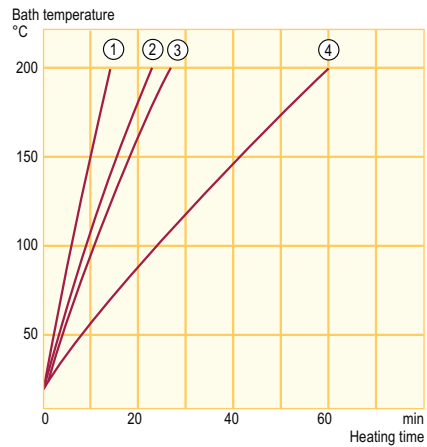

- ① RP 855 C
RP 845 C
RP 870 C
RP 890 C
- ② RP 1290 C
- ③ RP 1840 C
RP 1845 C
- ④ RP 3530 C

Temperature range
-88...200 °C

Standard accessories

Bath cover · 2 nipples and 4 closing plugs for pump connections · bath bridge heating for RP 1290 C

Recommended accessories

Reverse flow protection · automatic filling device · tubes ·
Optional modules: analogue, RS 232/485, contact, Profibus module · set of castors for RP 1290 C



All technical data from page 92
Other power supply variants on page 100

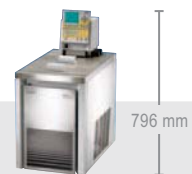
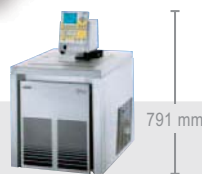

Technical features		RP 1290 C	RP 1840 C	RP 1845 C	RP 3530 C
Working temperature range*	°C	-88...200	-40...200	-50...200	-35...200
Temperature stability	±K	0.02	0.01	0.01	0.02
Heater power 115 V/208-220 V	kW	-/2.9	1.75/2.9	-/2.9	1.75/2.9
Cooling output at 20 °C	kW	1.1	0.9	1.6	0.9
Pump pressure max.	bar	0.7	0.7	0.7	0.7
Pump suction max.	bar	0.4	0.4	0.4	0.4
Pump flow (pressure) max.	L/min	25	25	25	25
Pump flow (suction) max.	L/min	23	23	23	23
Bath volume	L	15...17.5	12.5...19	12.5...19	23...35
Bath opening/depth	mm	300x150/200	300x200/200	300x200/200	300x350/250
Cat. No. 115 V; 60 Hz		-	LCK 4888	-	LCK 4890
Cat. No. 208-220 V; 60 Hz		LCK 8900	LCK 8888	LCK 8892	LCK 8890

* Working temperature range is equal to ACC range

LAUDA Proline Kryomats

Extra powerful cooling thermostats for bath applications from -90 up to 200 °C
LAUDA Proline Kryomats



Application examples

Constant temperatures

- Notch bending test
- Drop test

Changing temperatures

- Determination of pour point
- Brookfield test of lubricants
- Test of slide bearings



The new **Proline Kryomats** are floor-standing, low temperature thermostats suitable for a wide variety of applications. They never fail to impress through their compact design and high cooling capacities, especially at low temperatures. All Proline Kryomats are fitted with the Command remote control for easy and user-friendly operation. The units are equipped with a pressure pump optimized for internal

circulation adjustable from performance level five to eight. To prevent moisture in the atmosphere from condensing at low temperatures, bath bridge and bath edge heating are integrated into the design. Proline Kryomats stand out for having the latest technologies and an excellent price-performance ratio.

Your advantages at a glance



The Proline Kryomats advantages

Your benefits



- Removable Command control unit with graphic LCD display
- Automatic adjustment of the control parameters via integrated software for adaptive control

- Easy and intuitive operation. Quick setting changes
- Saves time-consuming calculation of control parameters



- Offset control head
- Integrated electrically heated cover plate and bath bridge heating
- Use of innovative cooling technology

- Allows installation of optional supplementary pumps for external applications
- Avoids condensation and ice build-up
- High cooling capacity and low operating temperatures with very small footprint



- Updated, adjustable pump nozzle

- Optimum circulation and temperature distribution throughout the entire bath



- Spacious baths with large bath openings
- Thread sleeves as standard on the edge of the bath

- Accommodates various sample shapes and sizes with efficient flow
- Allow for the fixing of testing equipment without further conversion measures



- Intelligent cooling fan control
- Optimised cooling airflow
- Internal release valve

- Optimum heat discharge while reducing noise emission
- Bath drain at front of unit
- No protruding release valve

LAUDA Proline Kryomats

Proline Kryomats Air-cooled cooling thermostats

The air-cooled Proline Kryomats have a working temperature range from -50 and -90 up to 200 °C. The models are available with bath volumes of 30 and 40 liters. The Proline SmartCool system, with its energy-saving digital cooling management, ensures that the cooling output is run in accordance with the application needs. That saves up to 75 percent of energy compared to standard cooling methods.

Two different booster pumps are available as accessories especially for external applications that require a considerable increase in volume flow/discharge pressure.



Cooling thermostat RP 4050 C



Cooling curves Heat transfer liquid: Ethanol, bath closed

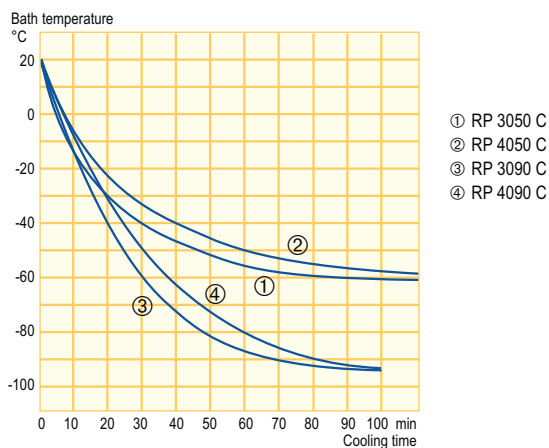

Temperature range
-90...200 °C

Standard accessories
Bath cover · 4 closing plugs for pump connections

Recommended accessories
Optional modules: analogue, RS 232/485, contact, Profibus module



All technical data from page 94
Other power supply variants on page 100



Technical features		RP 3050 C	RP 4050 C	RP 3090 C	RP 4090 C
Working temperature range*	°C	-50...200	-50...200	-90...200	-90...200
Temperature stability	±K	0.05	0.05	0.05	0.05
Heater power	kW	3.0	3.0	3.0	3.0
Cooling output at 20 °C	kW	5.0	5.0	3.0	3.0
Pump pressure max.	bar	0.5	0.5	0.5	0.5
Pump flow (pressure) max.	L/min	19	19	19	19
Bath volume	L	23...31	32...44	23...31	32...44
Bath opening/depth	mm	350x200/250	350x350/250	350x200/250	350x350/250
Cat. No. 208 V; 3/PE; 60 Hz		LUK 339	LUK 341	LUK 345	LUK 347

* Working temperature range is equal to ACC range

Proline Kryomats Water-cooled cooling thermostats

In the case of the water-cooled Proline Kryomats, the process heat is dissipated with the use of facility cooling water. This largely prevents unnecessary heating of the surrounding environment. As a result of this type of cooling, even higher cooling capacities are achieved than with the air-cooled units. The electronic cooling water management minimizes water consumption. The enhanced booster pumps, available as accessories, are particularly recommended for external applications where increased volume flow or greater pressures are required.



Cooling thermostat RP 4090 CW



Cooling curves Heat transfer liquid: Ethanol, bath closed

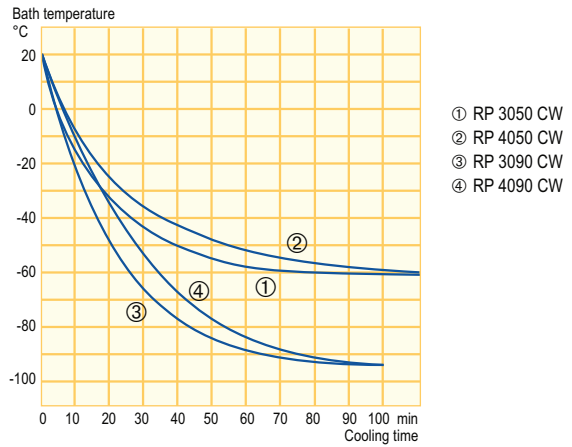

Temperature range
-90...200 °C

Standard accessories

Bath cover · 4 closing plugs for pump connections · G 3/4" lock-nut with 1/2" hose clip · 2 connectors 13 mm

Recommended accessories

Tubing for cooling water · Optional modules: analogue, RS 232/485, contact, Profibus module



All technical data from page 94
Other power supply variants on page 100



Technical features		RP 3050 CW	RP 4050 CW	RP 3090 CW	RP 4090 CW
Working temperature range*	°C	-50...200	-50...200	-90...200	-90...200
Temperature stability	±K	0.05	0.05	0.05	0.05
Heater power	kW	3.0	3.0	3.0	3.0
Cooling output at 20 °C	kW	6.0	6.0	4.0	4.0
Pump pressure max.	bar	0.5	0.5	0.5	0.5
Pump flow (pressure) max.	L/min	19	19	19	19
Bath volume	L	23...31	32...44	23...31	32...44
Bath opening/depth	mm	350x200/250	350x350/250	350x200/250	350x350/250
Cat. No.		208 V; 3/PE; 60 Hz LUK 340	LUK 342	LUK 346	LUK 348

* Working temperature range is equal to ACC range

LAUDA Proline

Proline accessories

Shut down valve/Reverse flow protection

Reverse flow protection when thermostating external systems, to avoid over-flow when pump stops, for retrofitting with LiBus. Temperature range -40...140 °C

Cat.-No.:	Description
LCZ 9673	Shut down valve reverse flow protection with LiBus
Suitable for	All Proline devices

Solenoid valve

Water-conscious cooling on heating thermostats for cooling water control. Controlled cooling operation for exothermal reactions or controlled cooling with programmer. Up to 155 °C bath temperature.

Cat.-No.:	Description	Temperature range
LCZ 9662	Solenoid valve with LiBus-connector	-10...155 °C
Suitable for	All heating and clear-view thermostats	

Baskets

For notch bending test

Cat.-No.:	Suitable for
LCZ 0658	RP 870, RP 870 C, RP 890, RP 890 C
LCZ 0694	RP 1290, RP 1290 C

Constant level device

Necessary for the constant liquid level when thermostating open external baths. Connection set: for wall thickness of bath vessel between 0 to 30 mm, with opening for thermometers 4 mm or 1.9 mm Ø and clamping gland HX 077 and HX 078.

Cat.-No.:	Description	Suitable for
LCZ 0660	Level controller, mechanical	P 8 (C), RP 845 (C) RP 855 (C)
LCZ 0679	Connection set for external inlet and outlet	LCZ 0660

Automatic filling device

For automatic replacement of liquid losses in thermostat bath, for example by evaporation. Also from vessels with max. 1 m suction height

Cat.-No.:	Description
LCZ 9661	Automatic filling device with LiBus

Controlled high-temperature chiller HTC with LiBus

For controlled cooling of thermostats in the operating temperature range up to 300 °C without formation of vapors, to be connected to external water cooling source.

Cat.-No.:	Description
LCZ 9663	Controlled high-temperature chiller HTC



Proline Kryomats accessories

Interface modules

An RS 232/485 interface is integrated as a standard feature. The control head is equipped for two interface modules to be plugged into the rear of the unit.

Cat. No.	Description	Description
LRZ 913	RS 232/485 interface	Electrically isolated, 9-pin SUB-D socket
LRZ 912	Analogue module	2 x In, 2 x Out, 0(4)...20 mA or 0...10 V
LRZ 915	Contact module SUB-D	3 x In, 3 x Out, 15-pin SUB-D
LRZ 914	Contact module NAMUR	1 x In, 1 x Out, NE 28, 2 DIN socket
LRZ 917	Profibus module	Electrically isolated, 9-pin SUB-D socket

Suitable tubings for heat transfer liquids and cooling water

Available upon request.

Booster pumps

For higher flow rates and pressure for external systems, connections M 30 x 1.5 O

Cat. No.	Description	Temperature range	Pressure max.	Pump flow max.
LWZ 080	EMP 174	-100...150 °C	0,9 bar	90 L/min
LWZ 086	EMP 081	-40...150 °C	3,2 bar	40 L/min

(O = outer thread)

Baskets

For notch bending test

Cat. No.	Suitable for
LUZ 008	RP 3050 C, RP 3050 CW, RP 3090 C, RP 3090 CW
LUZ 009	RP 4050 C, RP 4050 CW, RP 4090 C, RP 4090 CW

Pour point determination

Bath cover accomodates up to 16 metal beakers

Cat. No.	Suitable for
UP 065	RP 4050 C, RP 4050 CW, RP 4090 C, RP 4090 CW

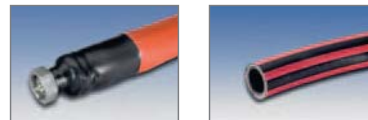

Order the detailed LAUDA accessories brochure and the heat transfer liquids brochure free of charge. This and additional product information can also be found at www.lauda.de

LAUDA Ultra USH High-temperature thermostats

High-temperature thermostats for special use for example in process engineering at temperatures from 20 up to 400 °C



Fields of application

- Process engineering
- High temperature applications
- Heating of distillation columns
- Special synthesis at high temperatures

Professional, high performance, broad temperature range

LAUDA Ultra USH high-temperature thermostats are compact heaters that require little space. If desired, they are also available with water counter-cooling. This allows rapid cooling

processes across the entire temperature range. The two-chamber structure with a cold oil blanket extends the life of the heat transfer liquid and reduces the operating costs.

Your advantages at a glance



The Ultra USH advantages

Your benefits



- Cold oil flooded two-chamber structure
- Hot heat transfer liquid does not come into contact with atmospheric oxygen
- Extends the life of the heat transfer liquid
- Reduces nuisances odors



- Remote control with a separate control module
- Control and visual inspection can be carried out from a remote location
- Operation while removed from the heating application

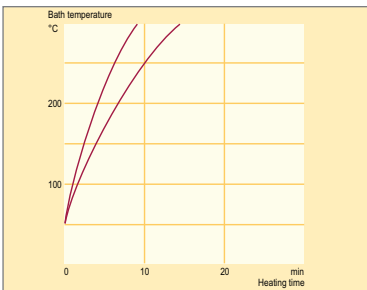

- Active heat transfer volume in the unit: 1.9 L only
- Allows rapid heating processes
- Minimum volume changes across the entire temperature range



- Controlled MVH cooler allows cooling across the entire temperature range from as low as 20 °C
- High cooling capacity up to 6 kW at 300 °C
- Intelligent valve control in the cooling circuits with special heat exchanger
- Cooling water can be used for cooling up to a thermostat's operating temperature of 400 °C without build up of vapor and pressure overlay



- Extremely compact design with high heating capacity
- Problem-free work directly at the application
- Short connecting hoses
- Limited space and area required

LAUDA Ultra USH

Ultra USH High-performance thermostat USH 400

The high-temperature thermostats of the USH 400 range with the controlled chiller MVH (available as an optional accessory) have been designed especially for the thermostating of external applications at high temperatures up to 400 °C. The controlled chiller MVH guarantees controlled cooling at any temperature. The special construction eliminates direct contact of the heat-transfer oil with atmospheric oxygen. Thanks to the optimised thermal separation of the cooling chamber for the cold oil blanket, there is no need for additional cooling up to an operating temperature of 250 °C. The heating capacity restriction and the low surface load of the heater ensure long service lives of the heat transfer medium.



USH 400 with MVH



Pump characteristics Heat transfer liquid: Water

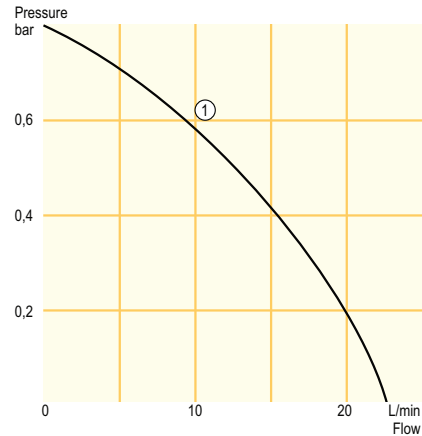

① USH 400
USH 400/6

Heating curves Heat transfer liquid: Ultra 300, bath closed

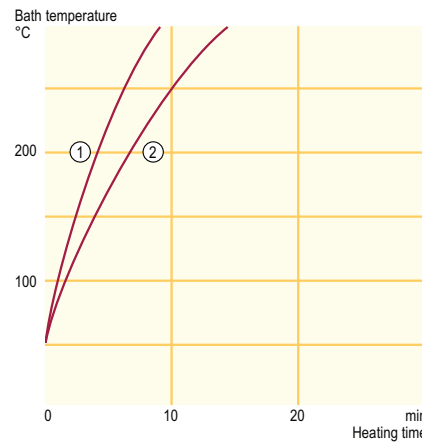

① USH 400 with 2 L ext.
② USH 400/6 with 2 L ext.

Temperature range

20...400 °C

Standard accessories

Nipples · screw caps · filler funnel · control unit



All technical data from page 90
Other power supply variants on page 99

Technical features		USH 400	USH 400/6
Working temperature range	°C	80...400*	80...400*
Temperature range with MVH	°C	20...400*	20...400*
Display resolution	°C	0.01	0.01
Temperature stability	±K	0.02...0.1	0.02...0.2
Heating capacity	kW	3.0	5.6
Cooling capacity with MHV (cooling water temperature 10 °C)	kW	6 at 300 °C, 2 at 100 °C	6 at 300 °C, 2 at 100 °C
Cooling water flow/pressure for MVH	L/min; bar	approx. 10; 0.5...6	approx. 10; 0.5...6
Pump pressure max.	bar	0.80	0.80
Pump flow (pressure) max.	L/min	22	22
Min. bath volume/with additional expansion vessel (1.2 L)	L	1.9/2.1	1.9/2.1
Expansion volume/with additional expansion vessel (1.2 L)	L	0.9/2.2	0.9/2.2
Loading	kW	3.2	5.8
Cat. No.		440-480 V; 3/PE; 60 Hz	LTH 209 (230 V; 60 Hz) LTH 611

* Heat transfer liquid available up to 350 °C only

Ultra USH High-performance thermostat USH 400

Thanks to the special two-chamber construction of the USH, the actual bath is divided into a heating chamber and a cold oil blanket which are completely thermally decoupled. The cold oil blanket is located above the actual heating chamber, which contains the heater and the pump. The two chambers are connected via tubes with small diameters. This enables the liquid from the heating chamber to expand into the cold oil blanket, yet no active heat exchange between the chambers occurs. Even at the maximum temperature, the surface temperature of the cold oil blanket always remains below 200 °C. This effect can be considerably improved by means of additional cooling with air or water. In order to further extend the service life of the heat transfer liquid, an inert gas blanket may be introduced onto the cold oil blanket.

Two-chamber construction

- ① Pump motor
- ② Inert gas blanket
- ③ Overflow
- ④ Cold oil blanket
- ⑤ Float
- ⑥ Cooling chamber for cold oil blanket
- ⑦ Connections for cooling chamber
- ⑧ Connection MVH
- ⑨ Pump outflow/return
- ⑩ Pump chamber
- ⑪ Heating chamber
- ⑫ Heater
- ⑬ Drain tap



Automatic vent valve

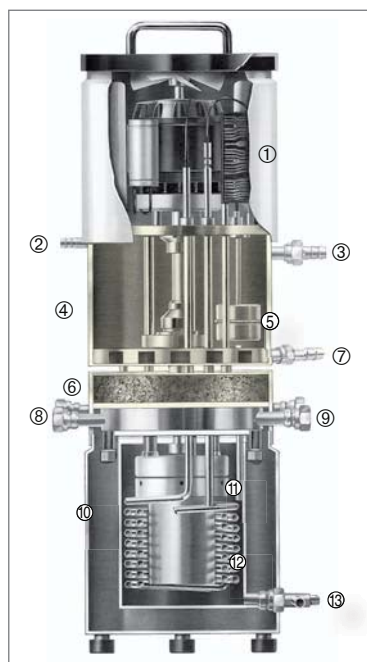

Ultra USH accessories

High temperature chiller

For controlled cooling of thermostats in the operating temperature range above 100 °C without formation of vapor, to be connected to external water cooling

Cat.-No.:	Description	suitable for
LTZ 034	Controlled high-temperature chiller MVH	USH 400, USH 400/6



Order the detailed LAUDA accessories brochure and the heat transfer liquids brochure free of charge. This and additional product information can also be found at www.lauda.de

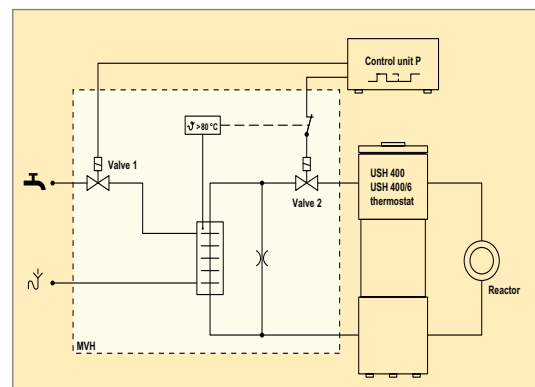

Working with controlled cooling MVH

LAUDA Integral

Process thermostats for professional external thermostating across a wide temperature range from -90 up to 300 °C



Application examples

- Process technology
- Process engineering
- Production
- Research
- Thermostating of stirrer tanks
- Temperature control of reactors in chemistry, pharmacy or biotechnology
- Thermal tests on test stands
- Use in material tests

Extremely flexible and rapid temperature change

Integral T and XT process thermostats are particularly suited for external temperature control of reactors, mini plants and calorimeters. They provide broad temperature ranges and rapid temperature changes. The temperature of external applications can be controlled precisely with defined heating and cooling speeds. With

the Integral T, internal circulation allows temperature control independently of external current resistances. The Integral XT units work on the basis of the flow principle with a cold oil blanket. As a result, significantly greater temperature ranges and quicker temperature changes are possible.

Your advantages at a glance



The Integral T advantages

Your benefits

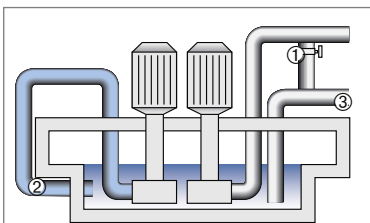

- Small active internal volume
- Bypass valve between inlet and outlet as a standard feature

- Rapid temperature change and effective control of exothermic reactions
- Pressure reducer to protect pressure-sensitive applications and glass



- Pivoting control unit with clear keypad and large display

- Easily accessible yet splash-water protected interfaces
- Easy and intuitive to operate

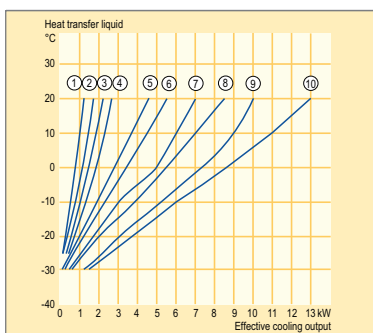

- Specific equipment range with heating capacities up to 9 kW and cooling capacities up to 13 kW
- Limited target temperature range from -25 to 150 °C

- Application-specific temperature control with high heating and cooling speeds
- Economical temperature control while eliminating unnecessary components and functions

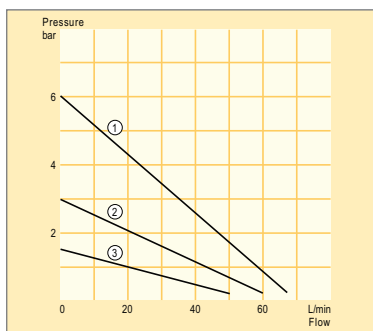

- Strong submersible pump, large expansion volume with overflow connection
- Additional pump as a standard feature with T 4600 units and larger
- Enhanced pump and low-pressure pump available as options

- Suitable for large external circuits
- Full cooling capacity independent from external flow
- May be adapted to various applications



- Compact design, all devices fitted with castors
- Remote control options available with use of accessory

- Saves valuable laboratory space
- Flexible applications
- Mounting and sub-assembly option

LAUDA Integral T

Integral T Process thermostats up to 2.7 kW

Integral T process thermostats make rapid thermostating with powerful heating and cooling capacities combined with a small active internal volume possible. This minimises thermal drift and exothermic reactions are effectively controlled. Its compact construction is space-saving and makes the Integral T mobile.

The T control unit can simply be flipped open. The following interfaces are then accessible from below: connector for standby contact input, malfunction (alarm) contact output, analogue inputs and outputs, external Pt 100 and serial RS 232/RS 485 interface.

From the T 4600 units and larger, the Integral T is equipped with an additional pump allowing for more powerful circulation in the internal circuit. An adjustable bypass valve between the supply pipe and the bath of the external circuit allows for pressure reduction (e.g. in order to protect pressure-sensitive applications).



Process thermostat T 2200



- Programmer with max. 150 temperature/time segments, for up to 5 programs
- Parallel display of 2 temperature values and discharge pressure
- External control via Pt100 temperature probe or standard signal
- Analogue inputs (3) and outputs (2), can be configured to 0...10 V or 0/4...20 mA
- Error message for low level, overtemperature, pumps and cooling compressor
- Remote "malfunction" display and stand-by switch via neutral contact
- RS 232/485 interface for PC and LAUDA Wintherm Plus control software

Pump characteristics Heat transfer liquid: Kryo 30

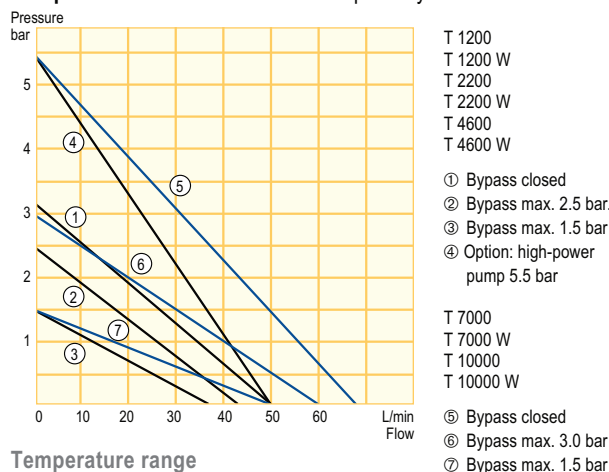

Temperature range
-25...120 °C (optional up to 150 °C)

Options T 1200...T 2200 W
Enlarged temperature range up to 150 °C · flow control instrument · low-pressure pump 1 bar, 30 L/min · high-power pump 5.5 bar

Recommended accessories T 1200...T 2200 W
Fiber-reinforced rubber tubing · insulation for rubber tubing · 4-port manifold · metal tube · remote control



All technical data from page 94
Other power supply variants on page 100

Technical features		T 1200	T 1200 W	T 2200	T 2200 W
Working temperature range*	°C	-25...120 **	-25...120 **	-25...120 **	-25...120 **
Temperature stability	±K	0.2	0.2	0.2	0.2
Heater power	kW	1.85	1.85	1.85	1.85
Cooling output at 20 °C	kW	1.2	1.6	2.2	2.7
Pump pressure max.	bar	3.2	3.2	3.2	3.2
Pump flow max.	L/min	40	40	40	40
Internal volume	L	3...7	3...7	3...7	3...7
Cat. No. 208-230 V; 60 Hz		LWP 801	LWP 802	LWP 803	LWP 804

* Working temperature range is equal to ACC range

** Available from -25 up to 150 °C upon request

Integral T Process thermostats up to 13 kW

The more powerful T 4600 to T 10000 W Integral process thermostats have a second pump for circulation in addition to the powerful circulating pump via an internal plate-type heat exchanger and therefore provide efficient and space-saving cooling. This enables a cooling capacity of 4.6 to 13 kW at 20 °C with the smallest internal bath volume.



Process thermostat T 7000



Heating curves Heat transfer liquid: Kryo 30 External volume: 10 L

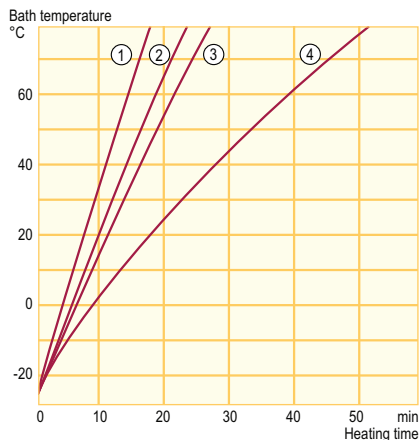

- ① T 10000 · T 10000 W
- ② T 4600 · T 4600 W
- ③ T 7000 · T 7000 W
- ④ T 1200 · T 1200 W
T 2200 · T 2200 W

Cooling output Heat transfer liquid: Ethanol

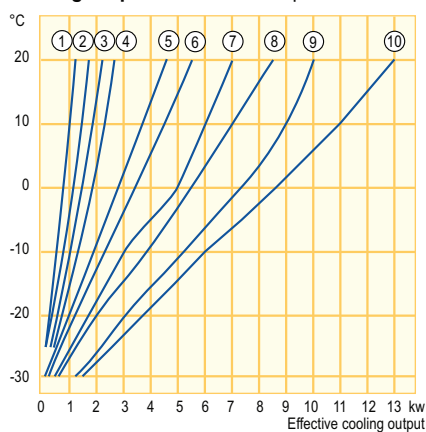

- ① T 1200
- ② T 1200 W
- ③ T 2200
- ④ T 2200 W
- ⑤ T 4600
- ⑥ T 4600 W
- ⑦ T 7000
- ⑧ T 7000 W
- ⑨ T 10000
- ⑩ T 10000 W

Temperature range

-30...120 °C (optional up to 150 °C)

Options T 4600...T 10000 W:

Enlarged temperature range up to 150 °C · flow control instrument · high-power pump 5.5 bar (only T 4600, T 4600 W)

Recommended accessories T 4600...T 10000 W:

Fiber-reinforced rubber tubing · insulation for rubber tubing · 4-port manifold · metal tube



All technical data from page 94
Other power supply variants on page 100

Technical features		T 4600	T 4600 W	T 7000	T 7000 W	T 10000	T 10000 W
Working temperature range*	°C	-30...120 **	-30...120 **	-30...120 **	-30...120 **	-30...120 **	-30...120 **
Temperature stability	±K	0.2	0.2	0.3	0.3	0.3	0.3
Heater power 208 V/440-480 V	kW	4.9/-	4.9/-	-/5.3	-/5.3	-/7.95	-/7.95
Cooling output at 20 °C	kW	4.6	5.5	7.0	8.5	10.0	13.0
Pump pressure max.	bar	3.2	3.2	6.0	6.0	6.0	6.0
Pump flow max.	L/min	40	40	60	60	60	60
Internal volume	L	6...18	6...18	8...20	8...20	8...20	8...20
Cat. No. 208 V; 3/PE; 60 Hz		LWP 305	LWP 306	-	-	-	-
Cat. No. 440-480 V; 3/PE; 60 Hz		-	-	LWP 607	LWP 608	LWP 609	LWP 610

* Working temperature range is equal to ACC range

** Available from -30 up to 150 °C upon request

LAUDA Integral XT

Extremely broad temperature range and rapid temperature changes:
LAUDA Integral XT



Application examples

- Temperature control of stirrer tanks
- Temperature control of reactors in chemistry, pharmacy or biotechnology
- Thermal tests on test stands
- Use in material tests



LAUDA Integral XT process thermostats allow extremely rapid temperature changes, resulting from the small, internal, thermally active heat transfer medium. The instruments work according to the highly

efficient flow principle with a broad working temperature range. The process thermostats are used where rapid temperature changes or high refrigeration and heating performance are required.

Your advantages at a glance



The Integral XT advantages

Your benefits

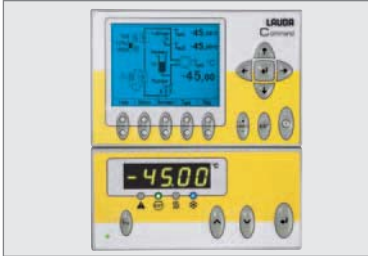

- Removable Command control unit with graphic LCD
- Automatic adjustment of the control parameters via integrated software for adaptive control

- Easy and intuitive operation, quick setting changes
- Saves time-consuming calculation of control parameters

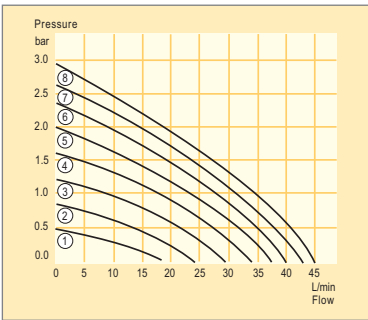

- Eight-level Vario pump adjustment
- Infinitely variable control of pump pressure
- Magnetically coupled pump

- Application-specific adaptation of flow and pressure to the application
- Pressure reduction to protect pressure-sensitive applications
- No sealing problems at the pump shaft across the entire temperature range



- Two slots for interface modules available
- RS 232/485 interface included

- High flexibility for the user for the broadest range of system integrations



- Recessed filler nozzle on the top of the equipment
- Practical drain taps on the sides of the equipment

- Simple filling with heat transfer liquid from the top of the unit
- Quick and complete drainage of the heat transfer liquid from the system

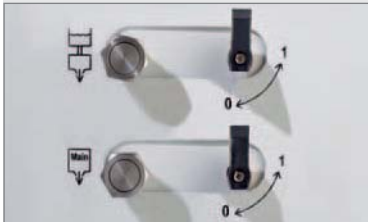

- Software-based/controlled filling and draining
- Automatic degassing after filling process

- Professional and safe start-up
- Temperature control of external application without gas introduction



- SelfCheck assistant shows equipment status clearly on the display

- High level of operating safety and constant monitoring of all equipment functions

LAUDA Integral XT

Integral XT Air-cooled process thermostats down to -80 °C

The LAUDA Integral XT process thermostats are ideally designed for the requirements of rapid and precise temperature control of an external application in process plant and pilot plant environments. The air-cooled process thermostats offer high performance in a small space while still providing functionality across a wide temperature range. Using the LAUDA Kryo 55 heat transfer liquid, temperatures from -50 up to 200 °C can be achieved without changing the heat transfer liquid. The special high-temperature version enables process temperatures up to 300 °C. This makes it ideal for reactor thermostating in chemical or pharmaceutical processes. The large expansion vessel in the LAUDA Integral XT absorbs temperature-induced changes in volume, thereby ensuring smooth operation even in large connected external systems.



Integral XT 750



Pump characteristics Heat transfer liquid: Water for all XT (except for XT 1850 W)

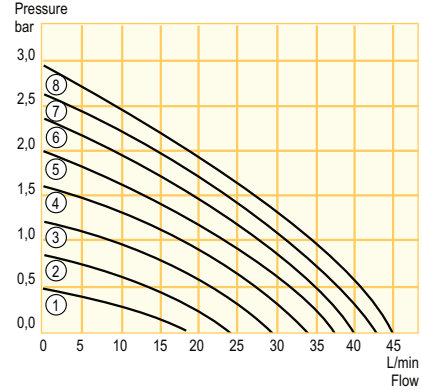

- ① Step 1
- ② Step 2
- ③ Step 3
- ④ Step 4
- ⑤ Step 5
- ⑥ Step 6
- ⑦ Step 7
- ⑧ Step 8

Cooling output Heat transfer liquid: Ethanol

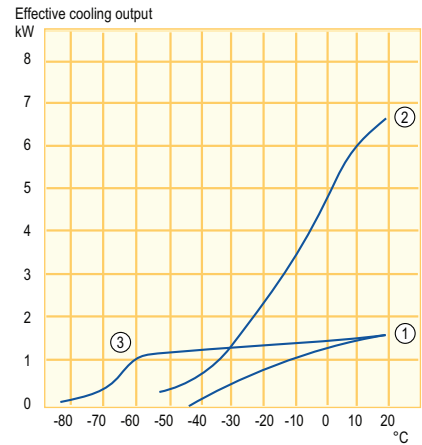

- ① XT 150
- ② XT 750 · XT 750 H
- ③ XT 280

Temperature range

-80...300 °C

All Integral XT include

Command remote control with RS 232/485 interface



All technical data from page 94
Other power supply variants
on page 100



660 mm



1285 mm



1285 mm



1285 mm

Technical features		XT 150	XT 280	XT 750	XT 750 H	
Working temperature range*	°C	-45...200	-80...200	-50...200	-50...300	
Temperature stability at -10 °C	±K	0.05	0.1	0.05	0.05	
Heater power	kW	2.9	3.0	5.7	5.7	
Cooling output at 20 °C	kW	1.5	1.5	6.7	6.7	
Pump pressure max.	bar	2.9	2.9	2.9	2.9	
Pump flow max.	L/min	45	45	45	45	
Filling volume min.	L	2.6	5.3	5.0	5.3	
Filling volume of expansion vessel	L	5.5	6.7	6.7	6.7	
Cat. No.		208-220 V; 3/PE; 60 Hz	LWP 812 (208-220 V; 60 Hz)	LWP 334	LWP 320	LWP 322

* Working temperature range is equal to ACC range

Integral XT

Water-cooled process thermostats down to -50 °C

Independent of variations in ambient temperature, Integral XT water-cooled process thermostats achieve constantly high cooling performance. The temperature of the ambient air remains virtually unchanged thanks to the dissipation of the process heat through the cooling water. This is a particular advantage in setups similar to production as in process plants or in the mini-plant, where work is conducted under the most strained conditions. Water-cooled Integral XT systems are also the perfect choice for air-conditioned spaces, since they do not tax or place an unnecessary burden on air-conditioning systems.



Integral XT 350 HW



Pump characteristics Heat transfer liquid: Water for all XT (except for XT 1850 W)

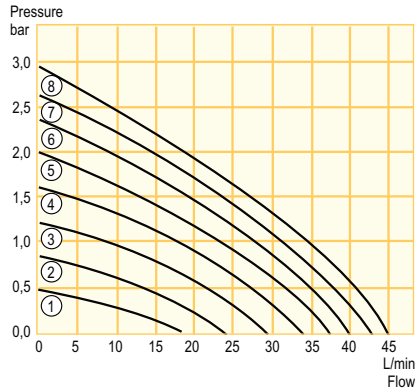

- ① Step 1
- ② Step 2
- ③ Step 3
- ④ Step 4
- ⑤ Step 5
- ⑥ Step 6
- ⑦ Step 7
- ⑧ Step 8

Cooling output Heat transfer liquid: Ethanol

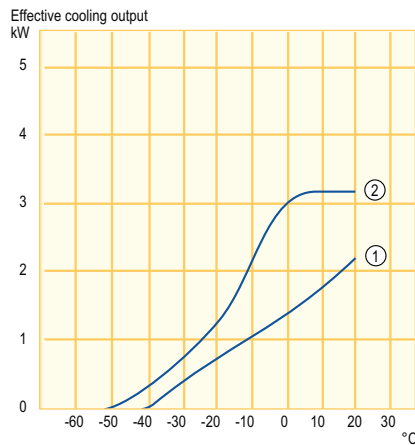

- ① XT 250 W
- ② XT 350 W · XT 350 HW

Temperature range
-50...300 °C

All Integral XT include
Command remote control with RS 232/485 interface



All technical data from page 94
Other power supply variants on page 100



660 mm



1285 mm



1285 mm

Technical features		XT 250 W	XT 350 W	XT 350 HW
Working temperature range*	°C	-45...200	-50...200	-50...300
Temperature stability at -10 °C	±K	0.05	0.1	0.1
Heater power	kW	2.9	2.9	2.9
Cooling output at 20 °C	kW	2.1	3.1	3.1
Pump pressure max.	bar	2.9	2.9	2.9
Pump flow max.	L/min	45	45	45
Filling volume min.	L	2.6	5.0	5.3
Filling volume of expansion vessel	L	5.5	6.7	6.7
Cat. No.		LWP 813	LWP 817	LWP 819

* Working temperature range is equal to ACC range

LAUDA Integral XT

Integral XT Water-cooled process thermostats down to -90 °C

The new LAUDA Integral XT 1590 W and XT 490 W process thermostats stand out for their high cooling capacities at very low temperatures. Thanks to the two-stage cascade system, the thermostats are particularly suited for applications in the ultra-low range down to -90 °C. The water-cooled devices achieve cooling capacities of up to 18.5 kW and maximum heating capacities of 10.4 kW. The Integral XT 1850 W is also available with a heating capacity of 16.0 kW.



Integral XT 1590 W



Pump characteristics Heat transfer liquid: Water for XT 1850 W

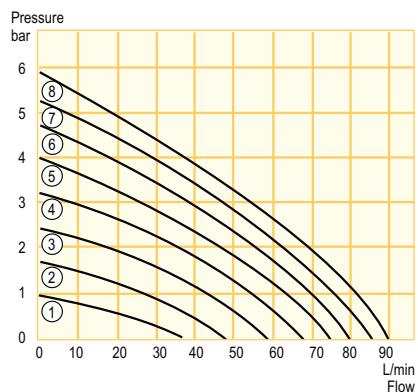

- ① Step 1
- ② Step 2
- ③ Step 3
- ④ Step 4
- ⑤ Step 5
- ⑥ Step 6
- ⑦ Step 7
- ⑧ Step 8

Cooling output Heat transfer liquid: Ethanol

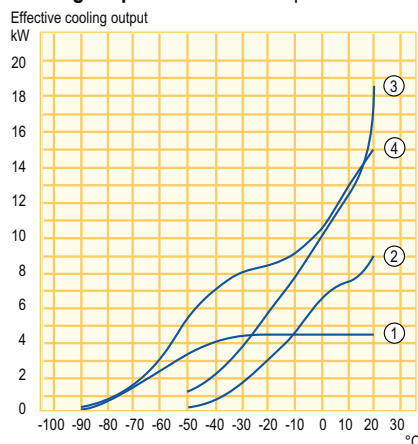

- ① XT 490 W
- ② XT 950 W
- ③ XT 1850 W
- ④ XT 1590 W

Temperature range

-90...200 °C

All Integral XT include

Command remote control with RS 232/485 interface



All technical data from page 94
Other power supply variants on page 100



Technical features		XT 950 W	XT 1850 W	XT 490 W	XT 1590 W
Working temperature range*	°C	-50...200	-50...200	-90...200	-90...200
Temperature stability at -10 °C	±K	0.1	0.3	0.1	0.3
Heater power 208-220 V/440-480 V	kW	5.7/-	-/14.0	5.7/-	-/7.0
Cooling output at 20 °C	kW	9.0	18.5	4.4	15.0
Pump pressure max.	bar	2.9**	5.8	2.9**	2.9**
Pump flow max.	L/min	45	90	45	45
Filling volume min.	L	5.0	9.0	9.5	10.5
Filling volume of expansion vessel	L	6.7	17.4	17.4	17.4
Cat. No. 208-220 V; 3/PE; 60 Hz		LWP 321	-	LWP 339	-
Cat. No. 440-480 V; 3/PE; 60 Hz		-	LWP 632	-	LWP 642

* Working temperature range is equal to ACC range ** Pump characteristics p. 63

Integral T accessories

Reinforced polymer tubings

Special polymer tubings for high pressures

Cat.-No.:	Description	Temp.-Range °C	max. pressure in bar
RKJ 031	Polymer tube 1/2", fiber-reinforced	-40...100	20
RKJ 032	Polymer tube 3/4", fiber-reinforced	-40...100	20
RKJ 033	Polymer tube 1", fiber-reinforced	-40...100	20
RKJ 103	Polymer tube 1/2", with textile insert	-40...120	9
RKJ 104	Polymer tube 3/4", with textile insert	-40...120	9
RKJ 105	Polymer tube 1", with textile insert	-40...120	3

Insulated metal hoses

For T 1200...T 4600						
Cat.-No.:	Description	Length/cm	Thread	d _i (mm)	d _e (mm)	Temp.-Range °C
LZM 075	MTK 100	100	G 3/4	20	47	-60...150
LZM 076	MTK 200	200	G 3/4	20	47	-60...150

For T 7000...T 10000						
Cat.-No.:	Description	Length/cm	Thread	d _i (mm)	d _e (mm)	Temp.-Range °C
LZM 078	MTK 101	100	G 1 1/4-G 1	25	50	-60...150
LZM 079	MTK 201	200	G 1 1/4-G 1	25	50	-60...150

d_i = internal diameter, d_e = external diameter

Manifold connectors

For joining multiple external systems (suitable for water/glycol and silicone oil)

Cat.-No.:	Description	Connection	Male thread	Temp.-Range °C
LWZ 084	Four-port manifold	G 3/4"	4 x 3/4"	-30...150
LWZ 075	Four-port manifold	G 3/4"	4 x 1/2"	-30...150
LWZ 085	Four-port manifold	G 3/4"	4 x 10 mm	-30...150
LWZ 082	Four-port manifold	G 1 1/4"	4 x 3/4"	-30...150

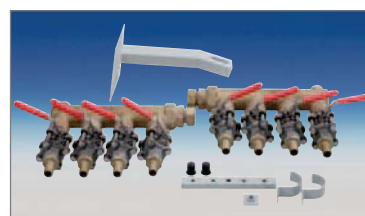

Options	Cat.-No.:	T 1200	T 1200 W*	T 2200	T 2200 W*	T 4600	T 4600 W*	T 7000	T 7000 W*	T 10000 W*	T 10000 W**
Enlarged temperature range up to 150 °C	LWZ 029	●	●	●	●	●	●	●	●	●	●
Flow control instrument	LWZ 035 LWZ 036	●	●	●	●	●	●	-	-	-	-
Low-pressure pump 1 bar, 30 L/min, 60-Hz version (see pump characteristics at the top of page 70)	LWZ 041-2	●	●	●	●	-	-	-	-	-	-
High-power pump 5.5 bar, 40 L/min 60-Hz version (see pump characteristics at the top of page 58)	LWZ 031-2 LWZ 032-2	●	●	●	●	-	-	-	-	-	-

* W = water-cooled version

LAUDA Integral XT

Integral XT accessories (excerpt)

Slot-in and interface modules

Cat. No.:	Description	Description
LRZ 912	Analogue module	2 x In, 2 x Out, 0(4)...20 mA or 0...10 V
LRZ 913	RS 232/485 interface	electrically isolated, 9-pin SUB-D
LRZ 914	Contact module NAMUR	1 x In, 1 x Out, NE 28, 2 DIN sockets
LRZ 915	Contact module SUB-D	3 x In, 3 x Out, 15-pin SUB-D
LRZ 917	Profibus interface	electrically isolated, 9-pin SUB-D



LRZ 912 LRZ 913 LRZ 914 LRZ 915 LRZ 917

High-pressure pump

Cat. No.:	Description	Description
LZW 077-1	High-pressure pump	Suitable for XT 150 to XT 950 W (230 V; 50 Hz), resulting max. pump pressure 5.8 bar



Metal hoses M30 x 1.5 I

Cat. No.:	Description	Length/cm	Temp. Range °C
LZM 081	MXC 100S	100	-50...300
LZM 082	MXC 200S	200	-50...300
LZM 083	MXC 300S	300	-50...300
Field of application	with special insulation for cooling and heating thermostats, for all heat transfer liquids		

(I = inner thread)



LZM 081

Metal hose M38 x 1.5 I

Cat. No.:	Description	Length/cm	Temp. Range °C
LZM 084	MX2C 100S	100	-50...300
LZM 085	MX2C 200S	200	-50...300
LZM 086	MX2C 300S	300	-50...300

(I = inner thread)



LZM 084

Integral XT accessories (excerpt)

Additional adapters and connectors

Cat. No.:	Description	Description
HKA 152	Reducer	M30 x 1.5 O on M16 x 1 I
UD 660	Reducer	M30 x 1.5 I on M16 x 1 O
HKA 164	Reducer	M38 x 1.5 O on M30 x 1.5 I
EOV 194	Screw-in stud	M30 x 1.5 O on G 3/4" A
EOV 207	Screw-in stud	M30 x 1.5 O on NPT 3/4" A
EOV 208	Double connectors	M30 x 1.5 O
EOV 206	Screw-in stud	M30 x 1.5 O on G 1" O
HKA 160	Adapter	M30 x 1.5 O on spherical line RD = 28
HKA 163	Flange adapter	M38 x 1.5 O on DIN 2633/DN40
HKA 165	Angle connector	M38 x 1.5 I on M38 x 1.5 A
HKA 153	Angle connector	M30 x 1.5 I on M30 x 1.5 A

(O = outer thread, I = inner thread)

Nipples

Best.-Nr.:	Description	Description
HKA 161	Nipple	1/2" Nipples on spherical line for M30 x 1.5
HKA 162	Nipple	3/4" Nipples on spherical line for M30 x 1.5
HKA 196	Screw cap	M30 x 1.5

Miscellaneous

Cat. No.:	Description	Description
LWZ 046	Bypass	M30 x 1.5 I/O Temperature range: -40...350 °C
LWZ 073	Ball valve	M30 x 1.5 I on M30 x 1.5 O Temperature range: -30 to 180°C
LWZ 074	Ball valve	M38 x 1.5 I on M38 x 1.5 O Temperature range: -30...180 °C

(O = outer thread, I = inner thread)



Detailed LAUDA Integral XT accessories information can also be found at www.lauda.de



Order the detailed LAUDA accessories brochure and the heat transfer liquids brochure free of charge. This and additional product information can also be found at www.lauda.de



EOV 206



HKA 152



UD 660



HKA 160



HKA 164



HKA 163



EOV 194



EOV 207



EOV 208



HKA 165



HKA 153



HKA 161



HKA 162

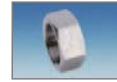

HKA 196



LWZ 046



LWZ 073

LWZ 074

LAUDA WK class

Circulation chillers with closed cooler circuit for continuous nonstop work in research, technology and production at temperatures from -30 up to 40 °C



Application examples

- Analytical devices such as electron microscopes, X-ray units, refractometers, distilling systems or AAS units
- Rotary evaporators and Soxhlet systems
- X-ray control systems e.g. at airports and semiconductor systems
- Control of cooling traps e.g. in the drying of gases
- Central cooling water supplies for complete laboratories to replace cooling with tap water

Reliable, large selection of models, compact construction

LAUDA WK class circulation chillers are used where operating heat has to be discharged reliably and quickly in chemical production processes or from technical systems – in harsh constant use environments. Unlike cooling with

tap water, they provide a constant temperature irrespective of the time of year and pressure fluctuations. The water saving also protects the environment and significantly reduces operating costs.

Your advantages at a glance



The WK class advantages

Your benefits



- 37 different models
- Cooling capacity from 230 W to 13 kW
- Independent cooling-water system instead of central cooling-water supply

- The right solution for all requirements
- Cooling-water temperature and pressure always constant
- Avoids the leakage of substances that are hazardous to the environment



- LED display and 3-button operation

- Easy operation

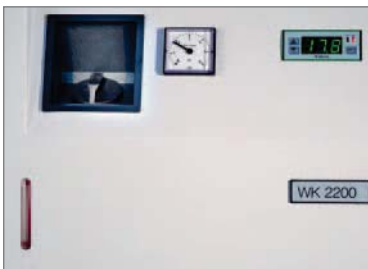

- Easily visible level display and discharge pressure display from WK 1200
- All devices with submersible pump

- Important operating parameters visible at a glance
- No seal problems at the pump shaft



- Below the bench height of 79 cm on units up to WK 2400
- Small footprint

- Fits under the standard laboratory bench top
- Saves valuable laboratory space

LAUDA WK class

WK class WK circulation chillers up to 600 W

The circulation chillers of the WK class are available with different cooling and pump configurations. The temperature range for all the units is from 0 up to 40 °C.

The LAUDA WK 300 was especially designed for simple cooling tasks down to 0 °C and is ideally suited for the use on the laboratory bench due to its compact size. The circulation chillers WK 500 and WK 502 differ in their cooling and pump output. The WK 502 was especially designed for the connection to atomic absorption spectrometers (ASS). Unlike the WK 500, it has an appropriately upgraded cooling unit and pump.



Circulation chiller WK 500



Pump characteristics Heat transfer liquid: Kryo 30

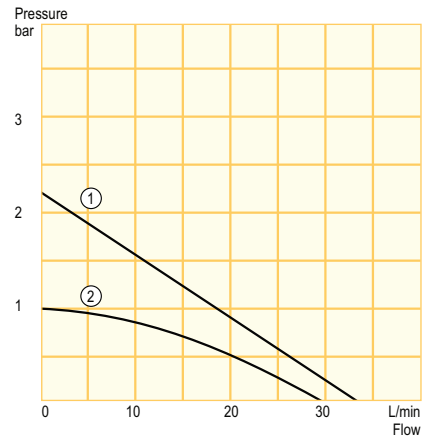

- ① WK 502
- ② WK 500
WK 1400 WK...
WK 2400 W
T 1200...T 2200 W
(1-bar pump)

Pump characteristics Heat transfer liquid: Kryo 30

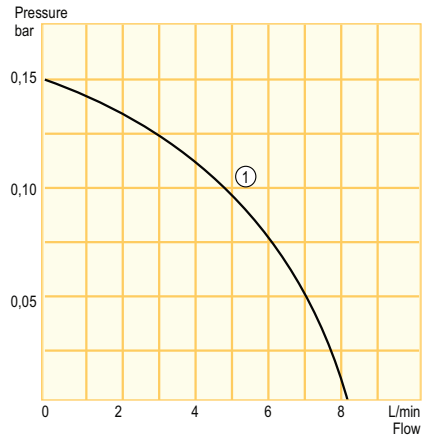

- ① WK 300 · WKL 230

Temperature range

0...40 °C

Standard accessories

Nipples · screw caps

Options (only WK 500, WK 502)

Digital interface RS 232/485, (LWZ 033) ·
flow control instrument (LWZ 034)

Recommended accessories

Fiber-reinforced rubber tubing 1/2" · insulation for
rubber tubing 1/2" · 4-port manifold



All technical data from page 96
Other power supply variants on page 101

Technical features		WK 300	WK 500	WK 502
Working temperature range*	°C	0...40	0...40	0...40
Temperature stability	±K	0.5	0.5	0.5
Cooling output at 20 °C	kW	0.31	0.50	0.60
Pump pressure max.	bar	0.15	1.0	2.2
Pump flow max.	L/min	8	30	33
Cat. No 100 V; 50 Hz/115 V; 60 Hz		LWM 717	LWG 732	–
Cat. No 230 V; 60 Hz		–	LWG 232	LWG 240

* Working temperature range is equal to ACC range

WK class WK circulation chillers up to 2.8 kW

The differences between the individual units are the effective cooling and pump outputs and the dimensions. All units can be supplied with water cooling (W). This enables greater cooling performance without heating of the surrounding laboratory environment.



Circulation chiller WK 1200



Pump characteristics Heat transfer liquid: Kryo 30

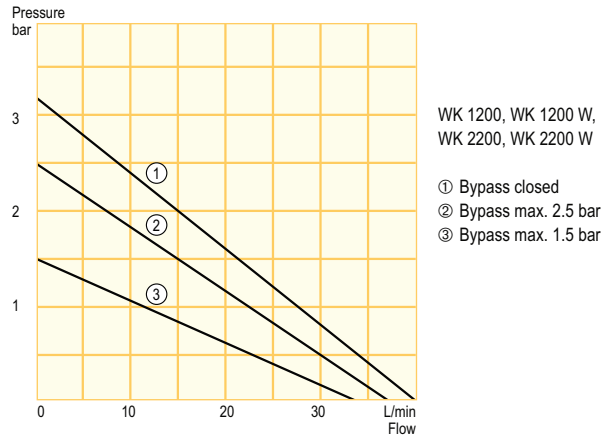

Temperature range

0...40 °C

Standard accessories

Nipples · screw caps · Water tubing – only WK 1200 W, WK 1400 W, WK 2200 W, WK 2400 W

Options

Digital interface RS 232/485 (LWZ 033) · flow control instrument (LWZ 035) · high-power pump 5.5 bar (LWZ 031) – only WK 1200, WK 1200 W, WK 2200, WK 2200 W

Recommended accessories

Fiber-reinforced rubber tubing $\frac{3}{4}$ " · insulation for rubber tubing $\frac{3}{4}$ " · 4-port manifold · fiber-reinforced rubber tubing $\frac{1}{2}$ " · insulation for rubber tubing $\frac{1}{2}$ "



All technical data from page 96
Other power supply variants on page 101

Technical features		WK 1200	WK 1200 W	WK 1400	WK 1400 W
Working temperature range*	°C	0...40	0...40	0...40	0...40
Temperature stability	±K	0.5	0.5	0.5	0.5
Cooling output at 20 °C	kW	1.2	1.5	1.4	1.7
Pump pressure max.	bar	3.2	3.2	1**	1**
Pump flow max.	L/min	40	40	30	30
Cat. No.	100 V; 50 Hz/115 V; 60 Hz	LWG 733	LWG 761	LWG 737	LWG 762

Technical features		WK 2200	WK 2200 W	WK 2400	WK 2400 W
Working temperature range*	°C	0...40	0...40	0...40	0...40
Temperature stability	±K	1	1	1	1
Cooling output at 20 °C	kW	2.2	2.6	2.4	2.8
Pump pressure max.	bar	3.2	3.2	1**	1**
Pump flow max.	L/min	40	40	30	30
Cat. No.	100 V; 50 Hz/115 V; 60 Hz	LWG 734	LWG 763	LWG 738	LWG 764

* Working temperature range is equal to ACC range

** Pump characteristics p. 70

LAUDA WK class

WK class WK circulation chillers up to 13 kW

The different cooling capacities are critical when selecting a unit. The WK class circulation chillers from 1 kW cooling capacity upwards are also available with water-cooling (W). In the more powerful WK 7000 to WK 10000 W circulation chillers, a second pump provides the internal circulation in addition to the pump for the external circuit. Thus the cooling capacity and temperature stability do not depend on the flow characteristics in the external circuit. These units can be supplied on request with water cooling (W). For these units, the use of water/glycol mixtures as heat transfer liquid is compulsory.

The LAUDA WK circulation chillers are available with different options, e.g. RS 232/485 interface and enhanced pumping systems.



Circulation chiller WK 7000



Pump characteristics Heat transfer liquid: Kryo 30

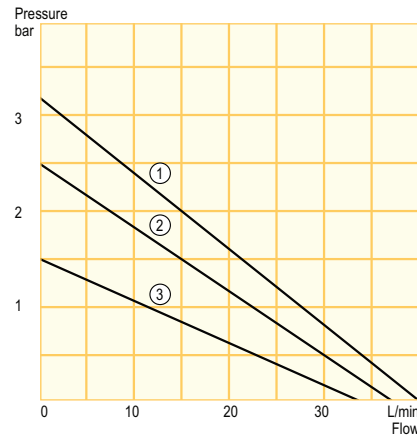

WK 3200 to
WK 10000 W

- ① Bypass closed
- ② Bypass max. 2.5 bar
- ③ Bypass max. 1.5 bar

Temperature range

0...40 °C

Standard accessories

Nipples · screw caps ·
Water tubing – only WK 3200 W, WK 4600 W

Options

High-power pump 5.5 bar (LWZ 032) ·
digital interface RS 232/485 (LWZ 033) ·
flow control instrument (LWZ 035)

Recommended accessories

Fiber-reinforced rubber tubing $\frac{3}{4}$ " · insulation for rubber tubing $\frac{3}{4}$ " ·
4-port manifold · fiber-reinforced rubber tubing $\frac{1}{2}$ " · insulation
for rubber tubing $\frac{1}{2}$ "



All technical data from page 96
Other power supply variants on page 101

Technical features		WK 3200	WK 3200 W	WK 4600	WK 4600 W
Working temperature range*	°C	0...40	0...40	0...40	0...40
Temperature stability	±K	1	1	0.5	0.5
Cooling output at 20 °C	kW	3.5	4.0	4.6	5.3
Pump pressure max.	bar	3.2	3.2	3.2	3.2
Pump flow max.	L/min	40	40	40	40
Cat. No. 208-230 V; 3/PE; 60 Hz		–	LWG 765**	LWG 336	LWG 758
Cat. No. 440-480 V; 3/PE; 60 Hz		–	–	LWG 636	–
Cat. No. 230 V; 3/PE; 60 Hz		LWG 135	LWG 165	–	LWG 158

Technical features		WK 7000	WK 7000 W	WK 10000	WK 10000 W
Working temperature range*	°C	0...40	0...40	0...40	0...40
Temperature stability	±K	0.5	0.5	0.5	0.5
Cooling output at 20 °C	kW	7.0	8.5	10.0	13.0
Pump pressure max.	bar	3.2	3.2	3.2	3.2
Pump flow max.	L/min	40	40	40	40
Cat. No. 208 V; 3/PE; 60 Hz		LWG 345	LWG 347	–	–
Cat. No. 440-480 V; 3/PE; 60 Hz		LWG 645	LWG 647	LWG 649	LWG 651

* Working temperature range is equal to ACC range ** 208 V; 3/PE; 60 Hz

WK class WKL circulation chillers up to 1 kW

The WKL 230 circulation chiller was especially designed for simple thermostating tasks below 0 °C. Thanks to its extremely compact construction and small footprint it fits anywhere. The temperature range of the WKL 230 is from -10 °C up to 40 °C with a temperature stability of ±0.5 K. The compact circulation chillers WKL 600 to WKL 1000 have different pumps and cooling performance.



Circulation chiller WKL 230



Pump characteristics Heat transfer liquid: Kryo 30

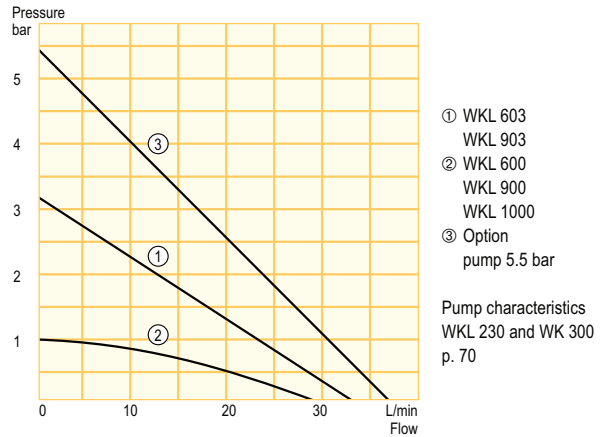

Temperature range

-25...40 °C

Standard accessories

Nipples · screw caps · bath cover (WKL 230)

Options (WKL 600...1000)

Digital interface RS 232/485 (LWZ 033) ·
flow control instrument (LWZ 034)

Additional accessories WKL 230...1000

EPDM-tube (only WKL 230) · fiber-reinforced rubber tubing 1/2" ·
insulation for rubber tubing 1/2" · 4-port manifold · adjustable
bypass and pressure indication (WKL 603 and WKL 903)



All technical data from page 96
Other power supply variants on page 101

Technical features		WKL 230	WKL 600	WKL 603
Working temperature range*	°C	-10...40	-25...40	-20...40
Temperature stability	±K	0.5	1.0	1.0
Cooling output at 20 °C	kW	0.23	0.65	0.52
Pump pressure max.	bar	0.15	1.0	3.2
Pump flow max.	L/min	8	30	33
Cat. No.	100 V; 50 Hz/115 V; 60 Hz	LWM 716	LWG 741	LWG 742

Technical features		WKL 900	WKL 903	WKL 1000
Working temperature range*	°C	-20...40	-15...40	-10...40
Temperature stability	±K	1.0	1.0	0.5
Cooling output at 20 °C	kW	0.95	0.8	1.0
Pump pressure max.	bar	1.0	3.2	1.0
Pump flow max.	L/min	30	33	30
Cat. No.	100 V; 50 Hz/115 V; 60 Hz	LWG 759	LWG 760	LWG 473 (115 V; 60 Hz)
Cat. No.	208-230 V; 60 Hz	LWG 859	LWG 860	-

* Working temperature range is equal to ACC range

LAUDA WK class

WK class WKL circulation chillers up to 13 kW

The WKL circulation chillers differ in terms of their cooling capacities and achieve temperatures of -10 °C (WKL 1200 to WKL 4600 W) or -30 °C (WKL 7000 to WKL 10000 W). All units are also available in the water-cooled design (W). With these units, the use of water/glycol mixtures as the heat transfer liquid is compulsory.



Circulation chiller WKL 7000



Pump characteristics Heat transfer liquid: Kryo 30

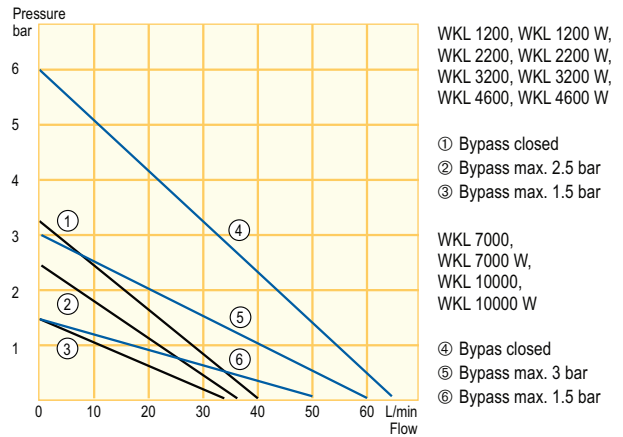

Temperature range

-30...40 °C

Standard accessories

Nipples · screw caps · Water tubing – only WKL 1200 W, WKL 2200 W, WKL 3200 W, WKL 4600 W, WKL 7000 W and WKL 10000 W

Options

Enlarged temperature range down to -25 °C to WKL 4600 (W) · RS 232/485 digital interface · flow control instrument · low-pressure pump 1 bar (30 L/min)*** · high-power pump 5.5 bar



All technical data from page 96
Other power supply variants on page 101

Technical features		WKL 1200	WKL 1200 W	WKL 2200	WKL 2200 W	WKL 3200	WKL 3200 W
Working temperature range*	°C	-10...40	-10...40	-10...40	-10...40	-10...40	-10...40
Temperature stability	±K	0.5	0.5	1.0	1.0	1.0	1.0
Cooling output at 20 °C	kW	1.2	1.6	2.2	2.7	3.5	4.2
Pump pressure max.	bar	3.2	3.2	3.2	3.2	3.2	3.2
Pump flow max.	L/min	40	40	40	40	40	40
Cat. No. 208-230 V; 60 Hz		LWG 853	LWG 866	LWG 854	LWG 867	–	–
Cat. No. 208-230 V; 3/PE; 60 Hz		–	–	–	–	LWG 755	LWG 768

Technical features		WKL 4600	WKL 4600 W	WKL 7000	WKL 7000 W	WKL 10000	WKL 10000 W
Working temperature range*	°C	-10...40	-10...40	-30...40	-30...40	-30...40	-30...40
Temperature stability	±K	0.5	0.5	0.5	0.5	0.5	0.5
Cooling output at 20 °C	kW	4.6	5.3	7.0	8.5	10.0	13.0
Pump pressure max.	bar	3.2	3.2	6.0	6.0	6.0	6.0
Pump flow max.	L/min	40	40	60	60	60	60
Cat. No. 208 V; 3/PE; 60 Hz		LWG 756**	LWG 757**	LWG 346	LWG 348	–	–
Cat. No. 440-480 V; 3/PE; 60 Hz		–	–	LWG 646	LWG 648	LWG 650	LWG 652

* Working temperature range is equal to ACC range ** 208-230 V; 3/PE; 60 Hz *** Pump characteristics p. 70

WK class accessories

Reinforced polymer tubing

Special polymer tubing (EPDM) for high pressures

Cat.-No.:	Description	Temp.-range °C	Max. pressure in bar
RKJ 031	Polymer tube 1/2" fiber-reinforced	-40...100	20
RKJ 032	Polymer tube 3/4" fiber-reinforced	-40...100	20
RKJ 033	Polymer tube 1" fiber-reinforced	-40...100	20



Manifold connectors

For joining multiple external systems (for water/glycol, not suitable for silicone oil)

Cat.-No.:	Description	Connection	Male thread	Temp.-range °C
LWZ 010	Four-port manifold	G 3/4"	4 x 3/4"	-10...100
LWZ 022	Four-port manifold	G 3/4"	4 x 1/2"	-10...100
LWZ 039	Four-port manifold	G 3/4"	4 x 10 mm	-10...100
LWZ 024	Four-port manifold	G 1 1/4"	4 x 3/4"	-10...100
LWZ 038	Four-port manifold	M 16 x 1	4 x 10 mm	-10...100
LWZ 009	Four-port manifold	M 16 x 2	4 x 1/2"	-10...100



Options ex works: WK circulation chillers up to 0 °C	Cat.-No.:	WK 300	WK 500	WK 502	WK 1200	WK 1200 W*	WK 1400	WK 1400 W*	WK 2200	WK 2200 W*	WK 2400	WK 2400 W*	WK 3200	WK 3200 W*	WK 4600	WK 4600 W*	WK 7000	WK 7000 W*	WK 10000	WK 10000 W*	
RS 232/485 digital interface	LWZ 033	-	•	•	•	•	•	•	•	•	•	•	•	•	•	•	•	•	•	•	•
Flow control instrument	LWZ 034	-	•	•	-	-	-	-	-	-	-	-	-	-	-	-	-	-	-	-	-
	LWZ 035	-	-	-	•	•	•	•	•	•	•	•	•	•	•	•	•	•	•	•	•
High-power pump 5.5 bar, 40 L/min. 60-Hz version (see pump characteristics on p. 73)	LWZ 031-2	-	-	-	•	•	-	-	•	-	-	-	-	-	-	-	-	-	-	-	-
	LWZ 032-2	-	-	-	-	-	-	-	-	-	-	-	•	•	•	•	•	•	•	•	•

Options ex works: WK circulation chillers down to -30 °C	Cat.-No.:	WKL 230	WKL 600	WKL 603	WKL 900	WKL 903	WKL 1000	WKL 1200	WKL 1200 W*	WKL 2200	WKL 2200 W*	WKL 3200	WKL 3200 W*	WKL 4600	WKL 4600 W*	WKL 7000	WKL 7000 W*	WKL 10000	WKL 10000 W*
Enlarged temperature range down to -25 °C	LWZ 030	-	-	-	-	-	-	•	•	•	•	•	•	-	-	-	-	-	-
RS 232/485 digital interface	LWZ 033	-	•	•	•	•	•	•	•	•	•	•	•	•	•	•	•	•	•
Flow control instrument	LWZ 034	-	•	•	•	•	•	-	-	-	-	-	-	-	-	-	-	-	-
	LWZ 035	-	-	-	-	-	-	•	•	•	•	•	•	•	•	-	-	-	-
	LWZ 036	-	-	-	-	-	-	-	-	-	-	-	-	•	•	•	•	•	•
Low-pressure pump 1 bar, 30 L/min. 60-Hz version (see pump characteristics on p. 70 above)	LWZ 041-2	-	-	-	-	-	-	•	•	•	-	-	-	-	-	-	-	-	-
High-power pump 5.5 bar, 40 L/min. 60-Hz version (see pump characteristics on p. 73)	LWZ 031-2	-	-	-	-	-	•	•	•	•	-	-	-	-	-	-	-	-	-
	LWZ 032-2	-	-	-	-	-	-	-	-	-	•	•	•	•	-	-	-	-	-

* W = water-cooled version



Order the detailed LAUDA accessories brochure and the heat transfer liquids brochure free of charge. This and additional product information can also be found at www.lauda.de

LAUDA Calibration thermostats

Calibration and adjustment with LAUDA calibration thermostats at temperatures from -40 up to 300 °C



Application examples

- Industrial production
- Testing institutes
- Calibration of thermometers
- Quality assurance in the production of temperature probes

High temperature stability, variable sample vessels, extensive range of devices and accessories

LAUDA Calibration thermostats are the first choice when it comes to temperature stability, greatest reliability, and homogeneity during calibration and adjustment. The high performance complete solutions for individual requirements are available in the Ecoline Staredition,

Proline, and Ultra models. They differ in terms of size, bath-opening, and useable depth. Thermostats, in particular, are superior to heating cabinets and metal block thermostats as the heat transfer into the heat transfer liquid is 40 to 60 times better than through the air.

Your advantages at a glance

+

The Calibration thermostats advantages

Your benefits



- Calibration thermostats available from three different product lines

- The ideal solution for any calibration task

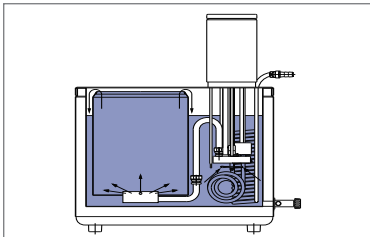

- Specifically constructed internal calibration chamber based on the overflow principle

- Outstanding spatial temperature distribution
- High temperature stability
- Consistent immersion depths

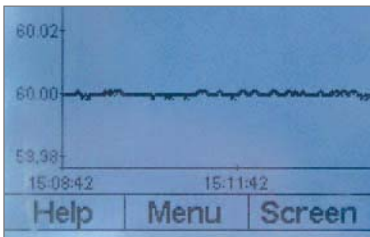

- Temperature stability of ± 0.005 K

- Allows reliable and accurate calibration of temperature measuring instruments



- Specially insulated low-temperature thermostats available
- Temperatures down to -40 °C achievable in conjunction with LAUDA cooling systems
- Intelligent control of the cooling system with the calibration thermostat

- Operation at low temperatures without formation of condensation on the outside of the devices
- Operate reliably even at high ambient temperatures
- Optimised adaptation to the application can be achieved by selection of the appropriate cooling unit
- Problem-free operation across the entire temperature range



- Extensive range of accessories available

- Reproducible submersion and calibration of the broadest range of test samples

LAUDA Calibration thermostats

Calibration thermostats Ecoline Staredition and Proline

The calibration thermostats of the LAUDA Ecoline Staredition range offer you temperature stabilities to ± 0.01 K at temperatures down to -30 °C. The RE 212 J model with its two-line display, digital interface and basic programmer is convincing. The even more user-friendly RE 312 J offers the possibility of external control for even better accuracy and the PC software LAUDA Wintherm Plus. In the heating range, the compact Proline PJ 12/PJ 12 C models reach maximum temperatures up to 300 °C. The PJL 12/PJL 12 C were designed especially for operation with the LAUDA DLK 45 through-flow cooler and reach temperatures down to -40 °C.



Heating curves Heat transfer liquid: Ultra 300, bath closed

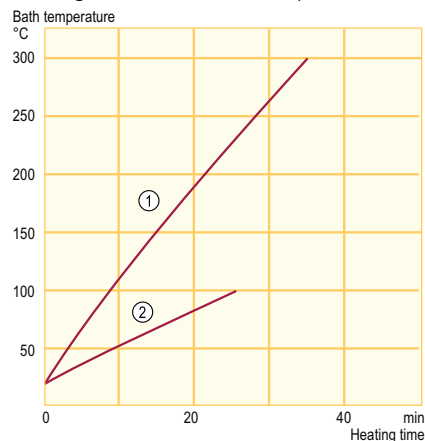

- ① PJ 12/PJ 12 C
PJL 12/PJL 12 C
to 200 °C
- ② RE 212 J
RE 312 J

Temperature range

$-40 \dots 300$ °C

Standard accessories

Nipples · screw caps · pump link (only RE 212 J and RE 312 J)

Recommended accessories

Bath cover · calibration racks



Ecoline Staredition RE 312 J

Proline PJ 12 C



All technical data from page 90
Other power supply variants on page 99

Technical features		RE 212 J	RE 312 J
Working temperature range*	°C	$-30 \dots 200$	$-30 \dots 200$
Temperature stability	\pm K	0.01	0.01
Resolution of indication	°C	0.05	0.05/0.01
Heater power	kW	1.3	1.3
Cooling output at 20 °C	kW	0.30	0.30
Pump pressure max.	bar	0.40	0.40
Pump flow (pressure) max.	L/min	17	17
Bath volume	L	9...12	9...12
Bath opening/usable depth	mm	\varnothing 150/180	\varnothing 150/180
Cat. No. 115 V; 60 Hz		LCK 4879	LCK 4880

Technical features		PJ 12	PJ 12 C	PJL 12	PJL 12 C
Working temperature range	°C	30...300	30...300	30...200	30...200
Operating temperature range	°C	0...300	0...300	$-40^{**} \dots 200$	$-40^{**} \dots 200$
Temperature stability	\pm K	0.01	0.01	0.01	0.01
Resolution of indication	°C	0.1	0.1/0.01/0.001	0.1	0.1/0.01/0.001
Heater power 115 V/208-220 V	kW	1.8/3.5	1.8/3.5	1.8/3.5	1.8/3.5
Pump pressure max.	bar	0.8	0.8	0.8	0.8
Pump flow (pressure) max.	L/min	25	25	25	25
Bath volume	L	8.5...13.5	8.5...13.5	8.5...13.5	8.5...13.5
Bath opening/depth	mm	\varnothing 120/320	\varnothing 120/320	\varnothing 120/320	\varnothing 120/320
Usable depth	mm	300	300	300	300
Cat. No. 115 V; 60 Hz		LCB 4720	LCB 4721	LCB 4718	LCB 4719
Cat. No. 208-220 V; 60 Hz		LCB 8720	LCB 8721	LCB 8718	LCB 8719

* Working temperature range is equal to the ACC range.

**At -40 °C in conjunction with LAUDA through-flow cooler DLK 45 (see page 82)

Calibration thermostats Ultra UB

LAUDA Ultra calibration thermostats offer excellent temperature stability and distribution values across a wide temperature range in the test chamber. The overflow principle ensures constant immersion depths here as well. The height of the liquid's surface can be changed to adjust completely immersed thermometers or other test objects. Thanks to its special insulation, the UB-JL range can be used with the LAUDA DLK 45 through-flow cooler down to -40 °C.



Ultra UB 30 J



Heating curves Heat transfer liquid: Ultra 300, bath closed

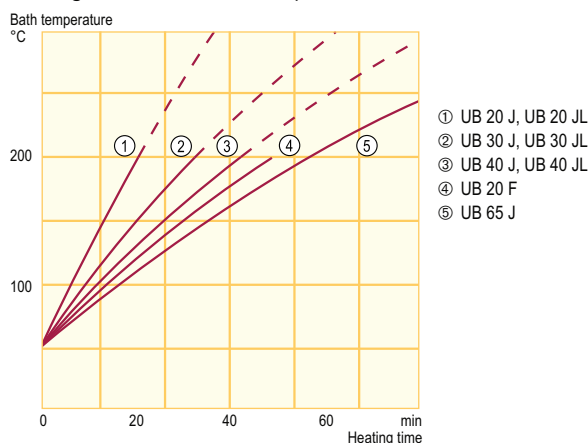

Temperature range

-40...300 °C

Standard accessories

Nipples · screw caps

Recommended accessories

Bath cover · calibration racks



All technical data from page 90

Other power supply variants on page 99

Technical features		UB 20 J	UB 30 J	UB 40 J	UB 65 J
Working temperature range*	°C	45...300	45...300	45...300	80...300
Temperature stability	±K	0.005...0.01	0.005...0.01	0.005...0.01	0.005...0.01
Resolution of indication	°C	0.01/0.001	0.01/0.001	0.01/0.001	0.01/0.001
Heater power	kW	3.0	3.0	3.0	3.0
Pump flow max.	bar	0.30	0.30	0.30	0.30
Pump flow (pressure) max.	L/min	15	15	15	15
Bath volume	L	15...18	22.5...30	32.5...40	48...54
Bath opening/depth	mm	Ø 195/195	Ø 195/320	Ø 195/450	Ø 215/690
Usable depth	mm	175	300	430	650
Cat. No. 230 V; 60 Hz		LTB 236	LTB 237	LTB 238	LTB 242**

Technical features		UB 20 F	UB 20 JL	UB 30 JL	UB 40 JL
Working temperature range	°C	35...200	45...200	45...200	45...200
Operating temperature range	°C	0...200	-40*...200	-40*...200	-35*...200
Temperature stability	±K	0.005	0.005...0.01	0.005...0.01	0.005...0.01
Resolution of indication	°C	0.01/0.001	0.01/0.001	0.01/0.001	0.01/0.001
Heater power	kW	1.2	3.0	3.0	3.0
Pump flow max.	bar	0.20	0.30	0.30	0.30
Pump flow (pressure) max.	L/min	12	15	15	15
Bath volume	L	15...18	15...18	22.5...30	32.5...40
Bath opening/depth	mm	Ø 195/195	Ø 195/195	Ø 195/320	Ø 195/450
Usable depth	mm	175	175	300	430
Cat. No. 230 V; 60 Hz		LTB 239	LTB 243	LTB 244	LTB 245

* At -40 or -35 °C in conjunction with LAUDA through-flow cooler DLK 45 (see page 82) ** 80 °C only with water

LAUDA Calibration thermostats

Calibration thermostats accessories

Calibration rack

Cat.-No.:	Qty. samples	Ø mm	suitable for
UG 092	180	6,5	UB 20 F, UB 20 J



Rotoracks

For thermometers or temperature probes for calibration purposes, all racks made from stainless steel, rotating and height adjustable

Cat.-No.:	Qty. samples	Ø mm	height adjustable	suitable for
UG 093	20	10	✓	UB 20 F, UB 20 J
UG 099	20	10	✓	UB 30 J
UG 100	20	10	✓	UB 40 J
UG 110	18	11	✓	RE 212 J, RE 312 J
UG 111	20	10	✓	RE 212 J, RE 312 J
UG 112	15	12	✓	PJ 12 (C), PJL 12 (C)



Bath cover stainless steel

Cat.-No.:	Description	suitable for
LTZ 032	Bath cover, circular with handle	UB 20 F, J, UB 30 J, UB 40 J, UB 65 J



Platinum resistance thermometers

For use on Pt100 inputs, stainless steel version to DIN EN 60751 (for connecting cables except for Pt100-94), with Lemo connection socket, accuracy class A



LAUDA Digital thermometers

Technical features	DigiCal DCM 2	DigiCal DCS 2
Measuring range	°C	-200...450
Resolution	°C	-200...200: 0.01 > 200: 0.1
Temperature probe	Pt100 KI. B1/3 DIN sheath resistance probe in 4-conductor	
Digital output as standard	RS 232, electrically isolated, on 8-pole DIN socket	RS 232, electrically isolated, with 9-pole Sub D socket on the rear
Cat. No.:	LMD 917	LMD 018 (230 V; 50/60 Hz)
Cat. No.:		LMD 818 (90-260 V; 50/60 Hz)



DigiCal DCM 2



DigiCal DCS 2



Order the detailed LAUDA accessories brochure and the heat transfer liquids brochure free of charge. This and additional product information can also be found at www.lauda.de

LAUDA Additional devices

Immersion coolers, through-flow coolers, circulation heat exchangers

Additional devices Immersion coolers

LAUDA through-flow coolers and immersion coolers are used as add-on devices to cool heating thermostats or any type of bath below ambient temperature. The preferred use of through-flow coolers is the use in conjunction with heating thermostats and integration into the cooling circuit.

LAUDA immersion coolers provide a quick way to extend the temperature range downwards when used in conjunction with heating thermostats, water baths and cooling traps. The thermostats work on the classical principle of direct evaporation, and the flexible hose connection means that they can be used without any problems. The ETK 50 even has adjustable temperature control.



Cooling using the LAUDA immersion cooler ETK 30



- Compact space-saving construction
- Carrying handles for easy transport
- Cooling coil made from high-grade stainless steel
- Flexible tube connection with special insulation (length 1.5 m)

Temperature range
-50...20 °C



Technical features			ETK 30	ETK 50
Working temperature range (without external heating)	°C		-40...20	-50...20
Operating temperature range (with external heating)	°C		-40...100	-50...100
Temperature probe			–	Pt 100
Control action			–	2-point action
Temperature stability (at -10 °C)	±K		–	0.5
Cooling output at	20 °C	kW	0.15	0.25
	-10 °C	kW	0.13	0.25
	-30 °C	kW	0.04	0.20
	-40 °C	kW	0.01	0.10
	-50 °C	kW	–	0.04
Cooling unit			air-cooled fully hermetic	air-cooled fully hermetic
Cooling coil (Ø x L)	mm		42x124	52x166
Base area (W x D x H)	mm		250x360x285	460x410x270
Weight	kg		17	33
Power consumption	kW		0.2	0.3
Cat. No.			LFE 002	on request

LAUDA Additional devices

Additional devices Through-flow coolers

LAUDA through-flow coolers upgrade any type of heating thermostat with pump connections to a high-quality cooling thermostat and thus allow working below ambient temperature. Through-flow coolers replace cooling with tap water that is expensive and ecologically not recommendable. They provide a constant flow and temperature of cooling supply regardless of the variations. Therefore, it is possible to ensure optimum temperature stability over the entire period and allow reproducible temperature conditions at any time.



- Air-cooled, fully hermetic and thus absolutely maintenance-free cooling aggregates with heat exchangers in reasonable dimensions.
- Heat exchangers are made from stainless steel.
- All refrigerated parts inside the through-flow cooler are perfectly insulated. Therefore no condensation of water or risk of corrosion.
- Low-noise emissions

Temperature range

-40...150 °C



Through-flow cooler DLK 10

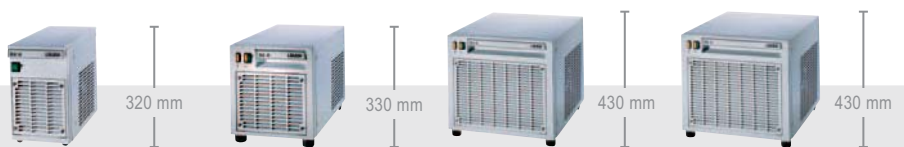

Technical features		DLK 10	DLK 25	DLK 45	DLK 45 LiBus
Working temperature range	°C	-15...150	-30...150	-40...150	-40...150
Cooling output at	20 °C kW	0.25	0.33	1.1	1.1
	0 °C kW	0.20	0.28	0.95	0.95
	-10 °C kW	0.10	0.25	0.85	0.85
	-20 °C kW	–	0.22	0.75	0.75
	-30 °C kW	–	0.20	0.55	0.55
	-40 °C kW	–	–	0.30	0.30
Heat exchanger connections for heat carrier		M 16x1, nipples Ø 13 mm	M 16x1, nipples Ø 13 mm	M 16x1, nipples Ø 13 mm	M 16x1, nipples Ø 13 mm
Special features		Control connection for mains supply		Proportional cooling: Ultras	Proportional cooling: Proline
Overall dimensions (W x D x H)	mm	200x400x320	290x540x330	470x560x430	470x560x430
Weight	kg	17	33	63	63
Power consumption	kW	0.2	0.5	0.9	0.9
Cat. No. 115 V; 60 Hz		LFD 710	LFD 708	–	–
Cat. No. 208-220 V; 60 Hz		–	–	LFD 809	LFD 811

Additional devices Circulation heat exchangers



LAUDA UWT circulation heat exchangers are an economical alternative to circulation chillers when central facility cooling circuits can be used. This is economically and ecologically practical if heat removal from processes has to be performed either regularly or at a high power, and the removed heat should not enter the ambient environment. Regulated circulation heat exchangers – also known as system separators – guarantee temperatures, pressures and volume flow rates adapt to the application. The LAUDA UWT take cooling water from an existing primary circulation system and thermostat an internal bath volume in an individually-adjustable manner: this bath volume is then transported to the application via a pump in the laboratory circulation system.



- A: Application
- B: UWT
- C: Facility cooling supply
- a: Inlet of coolant
- b: Return flow of coolant
- c: Flow pipe for application
- d: Return pipe for application
- 1: Heat exchanger
- 2: Bath vessel with heat transfer liquid
- 3: Immersion pump for circulation
- 4: Pressure indication for UWT 6000 and UWT 10000



- High pump capacity for good heat exchange
- High temperature stability even when there are temperature fluctuations in the primary circuit
- Compact design for easy installation
- High degree of process safety thanks to adapted cooling capacity
- Free of refrigerants

Temperature range

8...25 °C

Standard accessories

Hose connections · remote plug for external control

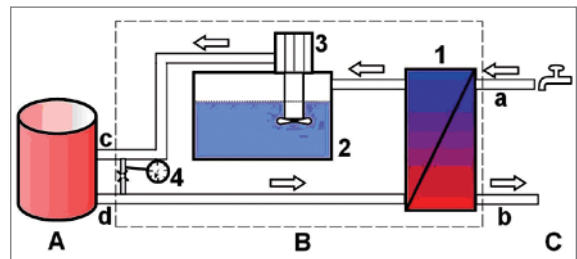

Schematic circuit diagram of LAUDA circulation heat exchangers



410 mm



480 mm



480 mm

Technical features		UWT 3000	UWT 6000	UWT 10000
Working temperature range	°C	8...25	8...25	8...25
Resolution of setting	°C	0.1	0.1	0.1
Resolution of indication	°C	0.1	0.1	0.1
Temperature stability	±K	1	1	1
Cooling capacity	kW	3	6	10
at coolant inlet temperature	°C	9	9	9
at coolant pressure loss	bar	0.12	0.05	0.07
at cooling circuit volume flow	L/min	6	16	20
at laboratory circuit inlet temperature	°C	14	14	14
at output UWT	L/min	6	6	20
Pump pressure max.	bar	1.0*	1.0*	2.2**
Flow max.	L/min	30	30	33
Cooling and lab circuit connections		G 3/4	G 1 1/4	G 1 1/4
Filling volume	L	7...12	35...45	35...45
Overall dimensions (W x D x H)	mm	350x480x410	550x650x480	550x650x480
Weight	kg	34	68	74
Power consumption	kW	0.2	0.2	0.5
Cat. No		on request	on request	on request

* Pump characteristics p. 70

** Also available with more powerful pump with 5.5 bar (LSW 1202); 40 L/min

LAUDA overview of accessories

Overview of accessories for constant temperature equipment

The operation of constant temperature equipment often requires the use of accessories. Only with the appropriate testing stands, connecting parts, reducers, various hose connections, distributors or interface modules, etc. the applications can be achieved successfully.

Additional equipment

Solenoid valve for cooling water control



Proline shut down valve/reverse flow protection



Level controller



Proline automatic filling device



Atherman illuminators



Alpha accessories



Temperature probes

Platinum resistance thermometers in stainless steel tube



Connecting cables

Connecting cables



- Match your LAUDA equipment exactly; developed, constructed or programmed specifically for it
- Tested for practicality – your LAUDA contact person knows what works and what is appropriate
- Robust – LAUDA accessories are designed for durability



Order the detailed LAUDA accessories brochure. This and additional product information can also be found at www.lauda.de

Connecting plugs

Connecting plugs



Bath covers

Stainless steel bath covers



Stainless steel gable covers



Cover plates for clear-view thermostats



Overview of accessories for constant temperature equipment

Racks, platforms, trays

Polycarbonate racks up to 100 °C



Polypropylene test tube racks, up to 95 °C



Stainless steel racks up to 100 °C

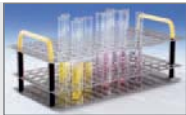

Stainless steel racks up to 300 °C

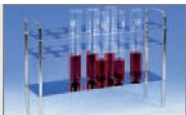

Stainless steel test tube racks up to 150 °C

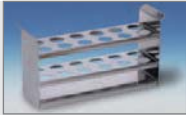

Racks for calibration thermostats

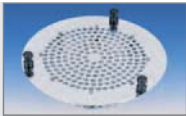

Platforms and adjustable platforms



Accessories for notch bending tests



Accessories for pour point determination



Tubing

Polymer tubing



Insulation tubing



Tubing

Polymer tubing (EPDM)

Metal tubes (stainless steel flexible tube)



Equipment trolley

Equipment trolley and castor base



Connectors

Connectors

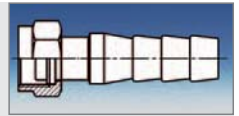

Screw caps

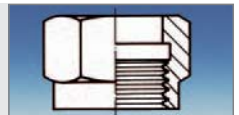

Manifold for temperature range -10...100 °C, for use with water/glycol



Manifold for temperature range -30...150 °C, for use with silicone oil/water/glycol

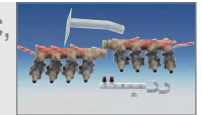

Integral XT bypass



Adapters



Double connectors



LAUDA Heat transfer liquids

Heat transfer liquids

Correct selection of the heat transfer liquid is of crucial importance for the safe and reliable operation of your thermostats. It must be suitable for the temperature range. In addition you should always use suitable tubing. More details can be found in our special brochure "Heat transfer liquids". Additional accessories are listed in the accessories brochure. Safety data sheets with the physical properties can be found on our website at www.lauda.de.

Thanks to our decades of experience and continual tests we can offer you optimum heat transfer liquids for all LAUDA thermostats. Heat transfer liquids are available in three drum sizes: 5, 10 and 20 liters. When calculating the amount to be ordered, please consider the volume of the thermostat and the external circulation in addition to the bath volume.

In the table below, you can see precisely which heat transfer liquids are suitable for which temperature ranges. Please note that these details always relate to the temperature range of the heat transfer liquid, which is the limiting factor.



- Highly accurate thermostating, even at extreme temperatures
- Durability
- Simple and safe handling
- Reliability, suitable for long-term operation
- Optimal for long thermostat life
- Best possible compatibility with the environment
- Safety data sheets available upon request



Order the detailed LAUDA brochure heat transfer liquids free of charge. This and additional product information can also be found at www.lauda.de

Open/half-open systems				
Designation	Temp. range	5 L	Cat. No.: 10 L	20 L
AquaStab	30...90 °C	LZB 123		
Aqua 90	5...90 °C	LZB 120	LZB 220	LZB 320
Kryo 85	Ⓢ -85...30 °C	LZB 113	LZB 213	LZB 313
Kryo 60	Ⓢ -60...80 °C	LZB 102	LZB 202	LZB 302
Kryo 51	Ⓢ -50...120 °C	LZB 121	LZB 221	LZB 321
Kryo 40	-40...60 °C	LZB 119	LZB 219	LZB 319
Kryo 30	-30...90 °C	LZB 109	LZB 209	LZB 309
Kryo 20	Ⓢ -20...180 °C	LZB 116	LZB 216	LZB 316
Therm 160	60...160 °C	LZB 106	LZB 206	LZB 306
Therm 180	Ⓢ 0...180 °C	LZB 114	LZB 214	LZB 314
Therm 200	Ⓢ 60...200 °C	LZB 117	LZB 217	LZB 317
Therm 240	Ⓢ 50...240 °C	LZB 122	LZB 222	LZB 322
Ultra 300	Ⓢ 80...300 °C	LZB 108	LZB 208	LZB 308
Ultra 350	80...200 °C	LZB 107	LZB 207	LZB 307

Closed systems flooded with cold oil (USH 400, Integral XT)				
Designation	Temp. range	5 L	Cat. No.: 10 L	20 L
Kryo 85	Ⓢ -90...140 °C	LZB 113	LZB 213	LZB 313
Kryo 55	Ⓢ -50...200 °C	LZB 124	LZB 224	LZB 324
Kryo 30	-30...90 °C	LZB 109	LZB 209	LZB 309
Ultra 350	30...350 °C	LZB 107	LZB 207	LZB 307

Ⓢ = Silicone oil

-100 °C -50 °C 0 °C 50 °C 100 °C 150 °C 200 °C 250 °C 300 °C

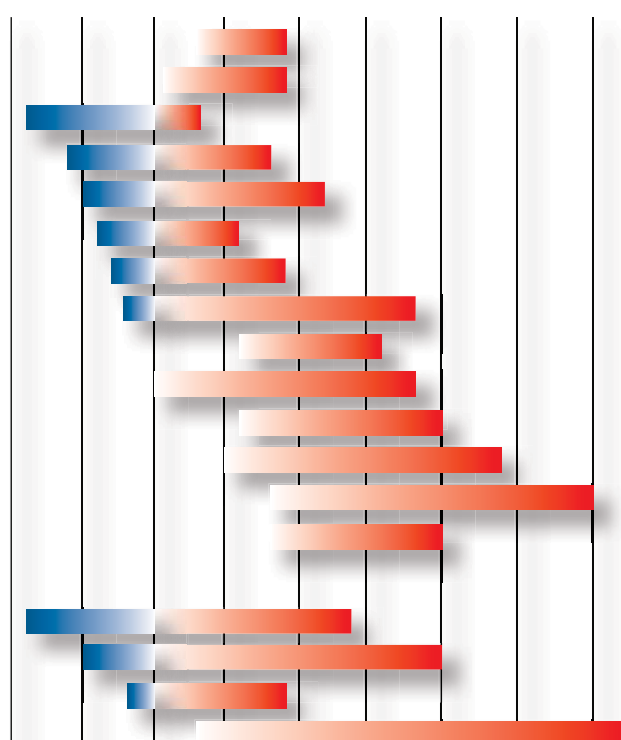

LAUDA Software

Wintherm Plus software

All LAUDA ECO Silver and ECO Gold thermostats, all Ecoline Staredition thermostats with control heads E 200 and E 300, all Proline thermostats and Proline Kryomats, all Ultra-thermostats, all circulation chillers WK/WKL with interface and all LAUDA Integral process thermostats can be controlled from any PC with the LAUDA Wintherm Plus software. Requirements of the PC: at least 64 MB RAM, serial interface.

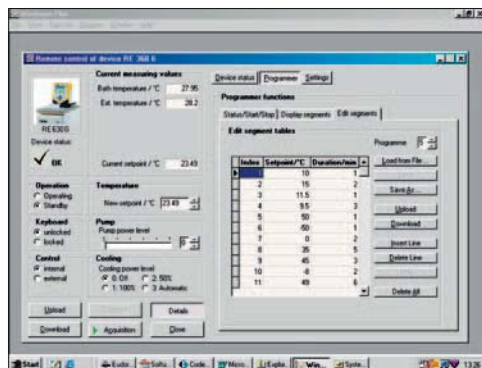
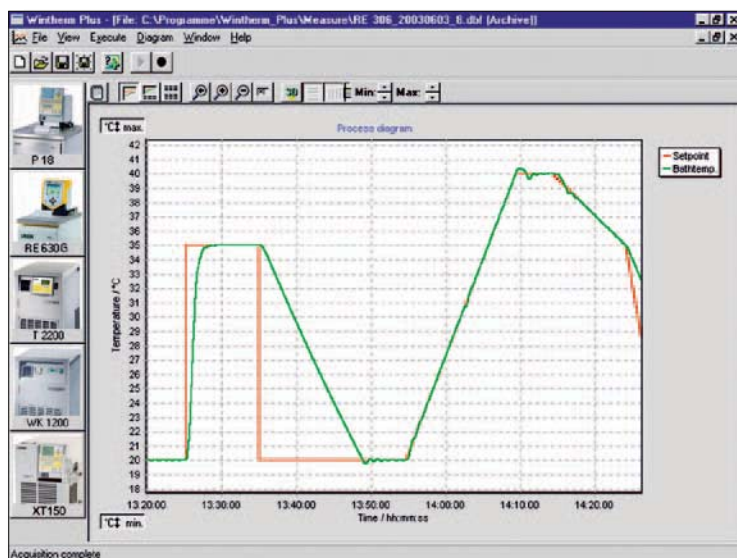

Wintherm Plus features

- Remotely setting temperature set-point and live observance of actual bath temperature
- Monitoring of external temperature values
- Online graphic display of all values with a readily selectable time window to reduce the amount of data or to increase resolution
- Temperature program editor to create and archive temperature profiles and ramps
- Complete control of all thermostat functions such as control parameters, temperature range and pump capacity*
- Each measuring graph can be imported as an ASCII file or D-Base database into spreadsheet programs such as Microsoft Excel.
- A separate read and display software makes it possible to view and print out existing graphs in parallel and independently of the controller sections.
- Read-out of the data logger for devices with remote control Command or ECO Gold thermostats.
- Every measuring curve can be imported directly as bitmap or metafile into all graphic programs and Microsoft Word.
- Simultaneous control of up to 64 thermostats
- Up to 8 serial interfaces of the PC can be addressed as RS 232 or RS 485.
- Automatic recognition of connected thermostats
- Operating languages: German and English
- Supported operation systems: Windows XP, Windows VISTA, Windows 7

* Pump capacity not controllable with Wintherm Plus on LAUDA USH, WK/WKL and Integral T

LAUDA Technical data according to DIN 12876 standard



Please note: all technical data from page 88 to 97 refer to the European power supply. Data for US-voltages are stated in the tables for technical data inside of the product line chapters as well as in the overview tables for power supply variants (pages 98 to 101). The differing data for cat. no., heater power and loading is included there as well.



Type	Page	Working temperature range ^① °C	Working temperature range with water-cooling ^② °C	Operating temperature range ^② °C	Resolution of setting °C	Resolution of indication °C	Temperature stability ±K	Safety fittings ^③	Heater power kW	Pump type ^④ bar	Pump pressure max. L/min	Pump flow max. (pressure) mm	Pump connection thread Ø Nipples mm
LAUDA Aqualine													
AL 2	12	25...95	–	–	0.1/1	0.1	0.2 [®]	I, NFL	0.5	–	–	–	–
AL 5	12	25...95	–	–	0.1/1	0.1	0.2 [®]	I, NFL	0.5	–	–	–	–
AL 12	12	25...95	–	–	0.1/1	0.1	0.2 [®]	I, NFL	1.0	–	–	–	–
AL 18	12	25...95	–	–	0.1/1	0.1	0.2 [®]	I, NFL	1.2	–	–	–	–
AL 25	12	25...95	–	–	0.1/1	0.1	0.2 [®]	I, NFL	1.2	–	–	–	–
LAUDA Alpha													
A	16	25...85	–	–	0.1/1	0.1	0.05	I, NFL	1.5	D	0.2	15	–
A 6	17	25...85	–	–	0.1/1	0.1	0.05	I, NFL	1.5	D	0.2	15	–
A 12	17	25...85	–	–	0.1/1	0.1	0.05	I, NFL	1.5	D	0.2	15	–
A 24	17	25...85	–	–	0.1/1	0.1	0.05	I, NFL	1.5	D	0.2	15	–
LAUDA ECO													
Silver	23	20...150	20...150	-20...150	0.01	0.01	0.01	III, FL	1.3	V	0.55	22	∅
Gold	23	20...200	20...200	-20...200	0.01	0.01	0.01	III, FL	2.6	V	0.55	22	∅
ET 6 S	27	20...100	20...100	-20...100	0.01	0.01	0.01	III, FL	1.3	V	0.55	22	∅
ET 12 S	27	20...100	20...100	-20...100	0.01	0.01	0.01	III, FL	1.3	V	0.55	22	∅
ET 15 S	27	20...100	20...100	-20...100	0.01	0.01	0.01	III, FL	1.3	V	0.55	22	∅
ET 20 S	27	20...100	20...100	-20...100	0.01	0.01	0.01	III, FL	1.3	V	0.55	22	∅
ET 6 G	27	20...100	20...100	-20...100	0.01	0.01	0.01	III, FL	2.6	V	0.55	22	∅
ET 12 G	27	20...100	20...100	-20...100	0.01	0.01	0.01	III, FL	2.6	V	0.55	22	∅
ET 15 G	27	20...100	20...100	-20...100	0.01	0.01	0.01	III, FL	2.6	V	0.55	22	M16x1 ∅
ET 20 G	27	20...100	20...100	-20...100	0.01	0.01	0.01	III, FL	2.6	V	0.55	22	∅
E 4 S	28	20...150	20...150	-20...150	0.01	0.01	0.01	III, FL	1.3	V	0.55	22	∅
E 10 S	28	20...150	20...150	-20...150	0.01	0.01	0.01	III, FL	1.3	V	0.55	22	∅
E 15 S	28	20...150	20...150	-20...150	0.01	0.01	0.01	III, FL	1.3	V	0.55	22	∅
E 20 S	28	20...150	20...150	-20...150	0.01	0.01	0.01	III, FL	1.3	V	0.55	22	∅
E 25 S	28	20...150	20...150	-20...150	0.01	0.01	0.01	III, FL	1.3	V	0.55	22	∅
E 40 S	28	20...150	20...150	-20...150	0.01	0.01	0.01	III, FL	1.3	V	0.55	22	∅
E 4 G	29	20...200	20...200	-20...200	0.01	0.01	0.01	III, FL	2.6	V	0.55	22	M16x1 ∅
E 10 G	29	20...200	20...200	-20...200	0.01	0.01	0.01	III, FL	2.6	V	0.55	22	∅
E 15 G	29	20...200	20...200	-20...200	0.01	0.01	0.01	III, FL	2.6	V	0.55	22	∅
E 20 G	29	20...200	20...200	-20...200	0.01	0.01	0.01	III, FL	2.6	V	0.55	22	∅
E 25 G	29	20...200	20...200	-20...200	0.01	0.01	0.01	III, FL	2.6	V	0.55	22	∅
E 40 G	29	20...200	20...200	-20...200	0.01	0.01	0.01	III, FL	2.6	V	0.55	22	∅

^① At pump level 1 ^② With external cooling/add-on cooler ^③ III, FL: for use with flammable and non-flammable liquids; I, NFL: for use with non-flammable liquids

^④ Pump connection sets for ECO Silver and ECO Gold available as accessories. See page 31.



Bath volume min.	Bath volume max.	Bath opening (WxD)	Bath depth	Usable depth	Height top of bath	Height gable cover	Dimensions (WxDxH)	Weight	Power supply®	Loading	Cat. No.	Type
L	L	mm	mm	mm	mm	mm	mm	kg	V; Hz	kW		
LAUDA Aqualine												
0.9	1.7	300x151	65	–	–	55	343x186x290	4.5	230; 50/60	0.6	LCB 0723	AL 2
1.0	5.0	300x151	150	–	–	55	343x186x290	5.0	230; 50/60	0.6	LCB 0724	AL 5
2.0	11.7	329x300	150	–	–	90	372x335x325	8.5	230; 50/60	1.1	LCB 0725	AL 12
3.0	18.2	505x300	150	–	–	90	548x335x325	11.5	230; 50/60	1.3	LCB 0726	AL 18
3.0	25.2	505x300	200	–	–	90	548x335x375	13.5	230; 50/60	1.3	LCB 0727	AL 25

LAUDA Alpha												
–	50.0	–	Min. 150	Min. 100	–	–	125x150x300	3.5	230; 50/60	1.5	LCEX 0226	A
2.5	5.5	145x161	150	130	212	–	181x332x370	6.2	230; 50/60	1.5	LCBX 0733	A 6
8	12	235x161	200	180	262	–	270x332x420	7.5	230; 50/60	1.5	LCBX 0734	A 12
18	25	295x374	200	180	262	–	332x535x420	10.5	230; 50/60	1.5	LCBX 0735	A 24

LAUDA ECO												
–	–	–	Min. 150	–	–	–	130x135x325	3.0	230; 50/60	1.4	LCE 0227	Silver
–	–	–	Min. 150	–	–	–	130x135x325	3.4	230; 50/60	2.7	LCE 0228	Gold
5.0	6.0	130x285	160	140	169	–	143x433x349	4.1	230; 50/60	1.4	LCM 0096	ET 6 S
9.5	12.0	300x175	160	140	208	–	322x331x389	6.4	230; 50/60	1.4	LCD 0286	E T 12 S
13.5	15.0	275x130	310	290	356	–	428x148x532	6.4	230; 50/60	1.4	LCD 0288	E T 15 S
15.0	20.0	300x350	160	140	208	–	322x506x389	7.6	230; 50/60	1.4	LCD 0290	E T 20 S
5.0	6.0	130x285	160	140	169	–	143x433x349	4.5	230; 50/60	2.7	LCM 0097	E T 6 G
9.5	12.0	300x175	160	140	208	–	322x331x389	6.8	230; 50/60	2.7	LCD 0287	E T 12 G
13.5	15.0	275x130	310	290	356	–	428x148x532	6.8	230; 50/60	2.7	LCD 0289	E T 15 G
15.0	20.0	300x350	160	140	208	–	322x506x389	8.0	230; 50/60	2.7	LCD 0291	E T 20 G
3.0	3.5	135x105	150	130	196	–	168x272x376	6.6	230; 50/60	1.4	LCB 0736	E 4 S
7.5	11.0	300x190	150	130	196	–	331x361x376	8.6	230; 50/60	1.4	LCB 0738	E 10 S
12.0	16.0	300x190	200	180	246	–	331x361x426	10.3	230; 50/60	1.4	LCB 0740	E 15 S
13.0	19.0	300x365	150	130	196	–	331x537x376	11.8	230; 50/60	1.4	LCB 0742	E 20 S
16.0	25.0	300x365	200	180	246	–	331x537x426	13.1	230; 50/60	1.4	LCB 0744	E 25 S
32.0	40.0	300x613	200	180	248	–	350x803x428	17.2	230; 50/60	1.4	LCB 0746	E 40 S
3.0	3.5	135x105	150	130	196	–	168x272x376	7.0	230; 50/60	2.7	LCB 0737	E 4 G
7.5	11.0	300x190	150	130	196	–	331x361x376	9.0	230; 50/60	2.7	LCB 0739	E 10 G
12.0	16.0	300x190	200	180	246	–	331x361x426	10.7	230; 50/60	2.7	LCB 0741	E 15 G
13.0	19.0	300x365	150	130	196	–	331x537x376	12.2	230; 50/60	2.7	LCB 0743	E 20 G
16.0	25.0	300x365	200	180	246	–	331x537x426	13.5	230; 50/60	2.7	LCB 0745	E 25 G
32.0	40.0	300x613	200	180	248	–	350x803x428	17.6	230; 50/60	2.7	LCB 0747	E 40 G

® D: pressure pump; V: Vario pump, pressure pump with 6 selectable pump levels

® Other power supply variants on page 98

® At 37 °C

LAUDA Technical data according to DIN 12876 standard



Please note: all technical data from page 88 to 97 refer to the European power supply. Data for US-voltages are stated in the tables for technical data inside of the product line chapters as well as in the overview tables for power supply variants (pages 98 to 101). The differing data for cat. no., heater power and loading is included there as well.

Type	Page	Working temperature range ① °C	Working temperature range with water cooling ② °C	Operating temperature range ③ °C	Resolution of setting °C	Resolution of indication °C	Temperature stability ±K	Safety fittings ④ kW	Heater power kW	Pump type ⑤ bar	Pump pressure max. bar	Pump suction max. L/min	Pump flow max. (pressure) L/min	Pump flow max. (suction) mm	Pump connection thread mm	Ø _n Nipples
LAUDA Proline																
P 5	36	35...300	20...300	-30...300	0.1/0.01	0.01	0.01	III, FL	3.5	VF	0.7	0.4	25	23	M16x1	13
P 8	36	35...300	20...300	-30...300	0.1/0.01	0.01	0.01	III, FL	3.5	VF	0.7	0.4	25	23	M16x1	13
P 12	36	30...300	20...300	-30...300	0.1/0.01	0.01	0.01	III, FL	3.5	VFP	1.1	-	32	-	M16x1	13
P 18	36	30...300	20...300	-30...300	0.1/0.01	0.01	0.01	III, FL	3.5	VF	0.7	0.4	25	23	M16x1	13
P 26	37	30...300	20...300	-30...300	0.1/0.01	0.01	0.01	III, FL	3.5	VF	0.7	0.4	25	23	M16x1	13
P 40	37	30...300*	20...300	-30...300*	0.01	0.1/0.01	0.01	III, FL	3.5	VF	0.7	0.4	25	23	M16x1	13
P 50	37	30...300*	20...300	-30...300*	0.01	0.1/0.01	0.01	III, FL	3.5	VF	0.7	0.4	25	23	M16x1	13
P 5 C	38	35...300	20...300	-30...300	0.01	0.1/0.01/0.001	0.01	III, FL	3.5	VF	0.7	0.4	25	23	M16x1	13
P 8 C	38	35...300	20...300	-30...300	0.01	0.1/0.01/0.001	0.01	III, FL	3.5	VF	0.7	0.4	25	23	M16x1	13
P 12 C	38	30...300	20...300	-30...300	0.01	0.1/0.01/0.001	0.01	III, FL	3.5	VFP	1.1	-	32	-	M16x1	13
P 18 C	38	30...300	20...300	-30...300	0.01	0.1/0.01/0.001	0.01	III, FL	3.5	VF	0.7	0.4	25	23	M16x1	13
P 26 C	39	30...300	20...300	-30...300	0.01	0.1/0.01/0.001	0.01	III, FL	3.5	VF	0.7	0.4	25	23	M16x1	13
P 40 C	39	30...300*	20...300	-30...300*	0.01	0.1/0.01	0.01	III, FL	3.5	VF	0.7	0.4	25	23	M16x1	13
P 50 C	39	30...300*	20...300	-30...300*	0.01	0.1/0.01	0.01	III, FL	3.5	VF	0.7	0.4	25	23	M16x1	13
PV 15	40	30...230	20...230	0...230	0.1/0.01	0.01	0.01	III, FL	3.5	VFP	0.8	-	25	-	M16x1	13
PV 24	40	30...230	20...230	0...230	0.1/0.01	0.01	0.01	III, FL	3.5	VFP	0.8	-	25	-	M16x1	13
PV 36	40	30...230	20...230	0...230	0.1/0.01	0.01	0.01	III, FL	3.5	VFP	0.8	-	25	-	M16x1	13
PV 15 C	40	30...230	20...230	0...230	0.01	0.1/0.01/0.001	0.01	III, FL	3.5	VFP	0.8	-	25	-	M16x1	13
PV 24 C	40	30...230	20...230	0...230	0.01	0.1/0.01/0.001	0.01	III, FL	3.5	VFP	0.8	-	25	-	M16x1	13
PV 36 C	40	30...230	20...230	0...230	0.01	0.1/0.01/0.001	0.01	III, FL	3.5	VFP	0.8	-	25	-	M16x1	13
PVL 15	40	30...100	20...100	-60...100	0.1/0.01	0.01	0.01	III, FL	3.5	VFP	0.8	-	25	-	M16x1	13
PVL 24	40	30...100	20...100	-60...100	0.1/0.01	0.01	0.01	III, FL	3.5	VFP	0.8	-	25	-	M16x1	13
PVL 15 C	40	30...100	20...100	-60...100	0.01	0.1/0.01/0.001	0.01	III, FL	3.5	VFP	0.8	-	25	-	M16x1	13
PVL 24 C	40	30...100	20...100	-60...100	0.01	0.1/0.01/0.001	0.01	III, FL	3.5	VFP	0.8	-	25	-	M16x1	13
PB	41	30...300	20...300	-30...300	0.1/0.01	0.01	0.01	III, FL	3.5	VF	0.7	0.4	25	23	M16x1	13
PB C	41	30...300	20...300	-30...300	0.01	0.1/0.01/0.001	0.01	III, FL	3.5	VF	0.7	0.4	25	23	M16x1	13
PBD	41	30...300	20...300	-30...300	0.1/0.01	0.01	0.01	III, FL	3.5	VFP	1.1	-	32	-	M16x1	13
PBD C	41	30...300	20...300	-30...300	0.01	0.1/0.01/0.001	0.01	III, FL	3.5	VFP	1.1	-	32	-	M16x1	13

* Max. temperature only with bath cover

LAUDA Ultra High-temperature thermostats																
USH 400	54	80...400	20...400*	0...400	0.01	0.01/0.001	0.02...0.1	III, FL	3.0	D	0.80	-	22	-	M16x1	13
USH 400/6	54	80...400	20...400*	0...400	0.01	0.01/0.001	0.02...0.2	III, FL	5.6	D	0.80	-	22	-	M16x1	13

* With controlled cooling MVH

LAUDA Calibration thermostats																
RE 212 J	78	-30...200	-	-	0.1/0.01	0.05	0.01	III, FL	2.25	V	0.40	-	17	-	M16x1	13
RE 312 J	78	-30...200	-	-	0.1/0.01	0.05/0.01	0.01	III, FL	2.25	V	0.40	-	17	-	M16x1	13
PJ 12	78	30...300	20...300	0...300	0.1/0.01	0.01	0.01	III, FL	3.5	VFP	0.8	-	25	-	M16x1	13
PJ 12 C	78	30...300	20...300	0...300	0.01	0.1/0.01/0.001	0.01	III, FL	3.5	VFP	0.8	-	25	-	M16x1	13
PJL 12	78	30...200	20...200	-40...200	0.1/0.01	0.01	0.01	III, FL	3.5	VFP	0.8	-	25	-	M16x1	13
PJL 12 C	78	30...200	20...200	-40...200	0.01	0.1/0.01/0.001	0.01	III, FL	3.5	VFP	0.8	-	25	-	M16x1	13
UB 20 J	79	45...300	20...300	-30...300	0.01	0.01/0.001	0.005...0.01	III, FL	3.0	D	0.30	-	15	-	M16x1	13
UB 30 J	79	45...300	20...300	-30...300	0.01	0.01/0.001	0.005...0.01	III, FL	3.0	D	0.30	-	15	-	M16x1	13
UB 40 J	79	45...300	20...300	-30...300	0.01	0.01/0.001	0.005...0.01	III, FL	3.0	D	0.30	-	15	-	M16x1	13
UB 65 J	79	80...300	20...300	-30...300	0.01	0.01/0.001	0.005...0.01	III, FL	3.0	D	0.30	-	15	-	M16x1	13
UB 20 JL	79	45...200	20...200	-40...200	0.01	0.01/0.001	0.005...0.01	III, FL	3.0	D	0.30	-	15	-	M16x1	13
UB 30 JL	79	45...200	20...200	-40...200	0.01	0.01/0.001	0.005...0.01	III, FL	3.0	D	0.30	-	15	-	M16x1	13
UB 40 JL	79	45...200	20...200	-35...200	0.01	0.01/0.001	0.005...0.01	III, FL	3.0	D	0.30	-	15	-	M16x1	13
UB 20 F	79	35...200	20...200	0...200	0.01	0.01/0.001	0.005	III, FL	1.2	D	0.20	-	12	-	M16x1	13

① At pump level 1

② With external cooling/add-on cooler

③ III, FL: for use with flammable and non-flammable liquids; I, NFL: for use with non-flammable liquids



Bath volume min.	Bath volume max.	Bath opening (WxD)	Bath depth	Usable depth	Height top of bath	Size of glass panel (WxH)	Dimensions (WxDxH)	Weight	Power supply [®]	Loading	Cat. No.	Type
L	L	mm	mm	mm	mm	mm	mm	kg	V; Hz	kW		
LAUDA Proline												
3.5	5.5	150x50	200	180	254	–	200x260x454	12.0	230; 50/60	3.6	LCB 0708	P 5
5.5	8.0	150x150	200	180	254	–	200x360x454	14.0	230; 50/60	3.6	LCB 0710	P 8
6.5	13.5	150x150	320	300	374	–	220x360x574	16.0	230; 50/60	3.6	LCB 0716	P 12
12.5	19.0	300x200	200	180	254	–	370x410x454	19.0	230; 50/60	3.6	LCB 0712	P 18
18.0	27.0	300x350	200	180	254	–	370x560x454	24.0	230; 50/60	3.6	LCB 0714	P 26
30.0	37.0	250x250	450	430	510	–	320x545x710	24.0	230; 50/60	3.6	LCB 0728	P 40
35.0	53.0	300x750	200	180	260	–	1025x350x454	24.0	230; 50/60	3.6	LCB 0730	P 50
3.5	5.5	150x50	200	180	254	–	200x260x454 [®]	12.0	230; 50/60	3.6	LCB 0709	P 5 C
5.5	8.0	150x150	200	180	254	–	200x360x454 [®]	14.0	230; 50/60	3.6	LCB 0711	P 8 C
6.5	13.5	150x150	320	300	374	–	220x360x574 [®]	16.0	230; 50/60	3.6	LCB 0717	P 12 C
12.5	19.0	300x200	200	180	254	–	370x410x454 [®]	19.0	230; 50/60	3.6	LCB 0713	P 18 C
18.0	27.0	300x350	200	180	254	–	370x560x454 [®]	24.0	230; 50/60	3.6	LCB 0715	P 26 C
30.0	37.0	250x250	450	430	510	–	320x545x710 [®]	24.0	230; 50/60	3.6	LCB 0729	P 40 C
35.0	53.0	300x750	200	180	260	–	1025x350x454 [®]	24.0	230; 50/60	3.6	LCB 0731	P 50 C
11.0	15.0	230x135	320	285	390	149x230	506x282x590	26.0	230; 50/60	3.6	LCD 0276	PV 15
19.0	24.0	405x135	320	285	390	326x230	740x282x590	36.0	230; 50/60	3.6	LCD 0278	PV 24
28.0	36.0	585x135	320	285	390	506x230	1040x282x590	44.0	230; 50/60	3.6	LCD 0280	PV 36
11.0	15.0	230x135	320	285	390	149x230	506x282x590 [®]	26.0	230; 50/60	3.6	LCD 0277	PV 15 C
19.0	24.0	405x135	320	285	390	326x230	740x282x590 [®]	36.0	230; 50/60	3.6	LCD 0279	PV 24 C
28.0	36.0	585x135	320	285	390	506x230	1040x282x590 [®]	44.0	230; 50/60	3.6	LCD 0281	PV 36 C
11.0	15.0	230x135	320	285	390	149x230	506x282x590	28.0	230; 50/60	3.6	LCD 0282	PVL 15
19.0	24.0	405x135	320	285	390	326x230	740x282x590	39.0	230; 50/60	3.6	LCD 0284	PVL 24
11.0	15.0	230x135	320	285	390	149x230	506x282x590 [®]	28.0	230; 50/60	3.6	LCD 0283	PVL 15 C
19.0	24.0	405x135	320	285	390	326x230	740x282x590 [®]	39.0	230; 50/60	3.6	LCD 0285	PVL 24 C
–	80.0	**	Min. 200	–	–	–	– x185x400	8.0	230; 50/60	3.6	LCG 0090	PB
–	80.0	**	Min. 200	–	–	–	– x185x520 [®]	8.0	230; 50/60	3.6	LCG 0091	PB C
–	80.0	**	Min. 320	–	–	–	– x185x400	8.0	230; 50/60	3.6	LCG 0092	PBD
–	80.0	**	Min. 320	–	–	–	– x185x520 [®]	8.0	230; 50/60	3.6	LCG 0093	PBD C

** The telescopic rod can be extended for bath widths 310...550 mm

LAUDA Ultra High-temperature thermostats												
1.9	2.1	–	–	–	–	–	Ø 180x540	21.5	230; 50	3.2	LTH 109	USH 400
1.9	2.1	–	–	–	–	–	Ø 180x540	24.5	400; 3/N/PE; 50	5.8	LTH 211	USH 400/6

LAUDA Calibration thermostats												
9.0	12.0	Ø 150	200	180	441	–	250x400x602	30.0	230; 50	2.3	LCK 1879	RE 212 J
9.0	12.0	Ø 150	200	180	441	–	250x400x602	30.0	230; 50	2.3	LCK 1880	RE 312 J
8.5	13.5	Ø 120	320	300	374	–	220x360x574	17.0	230; 50/60	3.6	LCB 0720	PJ 12
8.5	13.5	Ø 120	320	300	374	–	220x360x574 [®]	17.0	230; 50/60	3.6	LCB 0721	PJ 12 C
8.5	13.5	Ø 120	320	300	374	–	220x360x574	17.0	230; 50/60	3.6	LCB 0718	PJL 12
8.5	13.5	Ø 120	320	300	374	–	220x360x574 [®]	17.0	230; 50/60	3.6	LCB 0719	PJL 12 C
15.0	18.0	Ø 195	195	175	265	–	300x450x465	27.0	230; 50	3.2	LTB 136	UB 20 J
22.5	30.0	Ø 195	320	300	390	–	300x450x590	33.0	230; 50	3.2	LTB 137	UB 30 J
32.5	40.0	Ø 195	450	430	520	–	300x450x720	39.0	230; 50	3.2	LTB 138	UB 40 J
48.0	54.0	Ø 215	690	650	755	–	320x485x955	60.0	230; 50	3.2	LTB 142	UB 65 J
15.0	18.0	Ø 195	195	175	265	–	300x450x465	27.0	230; 50	3.2	LTB 143	UB 20 JL
22.5	30.0	Ø 195	320	300	390	–	300x450x590	33.0	230; 50	3.2	LTB 144	UB 30 JL
32.5	40.0	Ø 195	450	430	520	–	300x450x720	39.0	230; 50	3.2	LTB 145	UB 40 JL
15.0	18.0	Ø 195	195	175	265	–	300x450x465	27.0	230; 50	1.4	LTB 139	UB 20 F

[®] D: pressure pump; Du: Duplex pump, pressure/suction pump; V: Vario pump, pressure pump with 5 selectable output steps; VF: Varioflex pump, pressure/suction pump with 8 selectable output steps; VFP: Varioflex pump, pressure pump with 8 selectable output steps [®] Other power supply variants on page 98/99 [®] With Command remote control: 56 mm higher

LAUDA Technical data according to DIN 12876 standard



Please note: all technical data from page 88 to 97 refer to the European power supply. Data for US-voltages are stated in the tables for technical data inside of the product line chapters as well as in the overview tables for power supply variants (pages 98 to 101). The differing data for cat. no., heater power and loading is included there as well.



Type	Page	Working temperature range (equal to ACC range)①		Resolution of setting	Resolution of indication	Temperature stability	Safety fittings②	Heater power		Effective cooling output① (measured with ethanol, 20 °C ambient temperature)													
		°C	°C					°C	±K	kW	kW	150 °C (thermal oil)	20 °C	0 °C	-20 °C	-30 °C	-40 °C	-45 °C	-50 °C	-55 °C	-60 °C	-70 °C	-80 °C
LAUDA Alpha																							
RA 8	18	-25...85	0.1	0.1	0.05	I, NFL	1.5	0.225	0.16	0.08	-	-	-	-	-	-	-	-	-	-	-	-	-
RA 12	18	-25...85	0.1	0.1	0.05	I, NFL	1.5	0.325	0.26	0.08	-	-	-	-	-	-	-	-	-	-	-	-	-
RA 24	18	-25...85	0.1	0.1	0.05	I, NFL	1.5	0.425	0.33	0.08	-	-	-	-	-	-	-	-	-	-	-	-	-
LAUDA ECO																							
RE 415 S	24	-15...150	0.01	0.01	0.02	III, FL	1.3	0.18	0.12	0.03 [Ⓢ]	-	-	-	-	-	-	-	-	-	-	-	-	-
RE 420 S	24	-20...150	0.01	0.01	0.02	III, FL	1.3	0.20	0.15	0.03	-	-	-	-	-	-	-	-	-	-	-	-	-
RE 620 S	24	-20...150	0.01	0.01	0.02	III, FL	1.3	0.20	0.15	0.03	-	-	-	-	-	-	-	-	-	-	-	-	-
RE 630 S	24	-30...150	0.01	0.01	0.02	III, FL	1.3	0.30	0.24	0.10	0.02	-	-	-	-	-	-	-	-	-	-	-	-
RE 1050 S	24	-50...150	0.01	0.01	0.02	III, FL	1.3	0.70	0.60	0.35	0.19	0.10	-	0.02	-	-	-	-	-	-	-	-	-
RE 1225 S	24	-25...150	0.01	0.01	0.02	III, FL	1.3	0.30	0.24	0.09	0.04 [Ⓢ]	-	-	-	-	-	-	-	-	-	-	-	-
RE 2025 S	24	-25...150	0.01	0.01	0.02	III, FL	1.3	0.30	0.23	0.06	0.03 [Ⓢ]	-	-	-	-	-	-	-	-	-	-	-	-
RE 415 G	25	-15...200	0.01	0.01	0.02	III, FL	2.6	0.18	0.12	0.03 [Ⓢ]	-	-	-	-	-	-	-	-	-	-	-	-	-
RE 420 G	25	-20...200	0.01	0.01	0.02	III, FL	2.6	0.20	0.15	0.03	-	-	-	-	-	-	-	-	-	-	-	-	-
RE 620 G	25	-20...200	0.01	0.01	0.02	III, FL	2.6	0.20	0.15	0.03	-	-	-	-	-	-	-	-	-	-	-	-	-
RE 630 G	25	-30...200	0.01	0.01	0.02	III, FL	2.6	0.30	0.24	0.10	0.02	-	-	-	-	-	-	-	-	-	-	-	-
RE 1050 G	25	-50...200	0.01	0.01	0.02	III, FL	2.6	0.70	0.60	0.35	0.19	0.10	-	0.02	-	-	-	-	-	-	-	-	-
RE 1225 G	25	-25...200	0.01	0.01	0.02	III, FL	2.6	0.30	0.24	0.09	0.04 [Ⓢ]	-	-	-	-	-	-	-	-	-	-	-	-
RE 2025 G	25	-25...200	0.01	0.01	0.02	III, FL	2.6	0.30	0.23	0.06	0.03 [Ⓢ]	-	-	-	-	-	-	-	-	-	-	-	-
RE 415 SW	26	-15...150	0.01	0.01	0.02	III, FL	1.3	0.18	0.12	0.03 [Ⓢ]	-	-	-	-	-	-	-	-	-	-	-	-	-
RE 420 SW	26	-20...150	0.01	0.01	0.02	III, FL	1.3	0.20	0.15	0.03	-	-	-	-	-	-	-	-	-	-	-	-	-
RE 620 SW	26	-20...150	0.01	0.01	0.02	III, FL	1.3	0.20	0.15	0.03	-	-	-	-	-	-	-	-	-	-	-	-	-
RE 630 SW	26	-30...150	0.01	0.01	0.02	III, FL	1.3	0.30	0.24	0.10	0.02	-	-	-	-	-	-	-	-	-	-	-	-
RE 1050 SW	26	-50...150	0.01	0.01	0.02	III, FL	1.3	0.70	0.60	0.35	0.19	0.10	-	0.02	-	-	-	-	-	-	-	-	-
RE 1225 SW	26	-25...150	0.01	0.01	0.02	III, FL	1.3	0.30	0.24	0.09	0.04 [Ⓢ]	-	-	-	-	-	-	-	-	-	-	-	-
RE 2025 SW	26	-25...150	0.01	0.01	0.02	III, FL	1.3	0.30	0.23	0.06	0.03 [Ⓢ]	-	-	-	-	-	-	-	-	-	-	-	-
RE 415 GW	26	-15...200	0.01	0.01	0.02	III, FL	2.6	0.18	0.12	0.03 [Ⓢ]	-	-	-	-	-	-	-	-	-	-	-	-	-
RE 420 GW	26	-20...200	0.01	0.01	0.02	III, FL	2.6	0.20	0.15	0.03	-	-	-	-	-	-	-	-	-	-	-	-	-
RE 620 GW	26	-20...200	0.01	0.01	0.02	III, FL	2.6	0.20	0.15	0.03	-	-	-	-	-	-	-	-	-	-	-	-	-
RE 630 GW	26	-30...200	0.01	0.01	0.02	III, FL	2.6	0.30	0.24	0.10	0.02	-	-	-	-	-	-	-	-	-	-	-	-
RE 1050 GW	26	-50...200	0.01	0.01	0.02	III, FL	2.6	0.70	0.60	0.35	0.19	0.10	-	0.02	-	-	-	-	-	-	-	-	-
RE 1225 GW	26	-25...200	0.01	0.01	0.02	III, FL	2.6	0.30	0.24	0.09	0.04 [Ⓢ]	-	-	-	-	-	-	-	-	-	-	-	-
RE 2025 GW	26	-25...200	0.01	0.01	0.02	III, FL	2.6	0.30	0.23	0.06	0.03 [Ⓢ]	-	-	-	-	-	-	-	-	-	-	-	-
LAUDA Proline																							
RP 845	42	-45...200	0.1/0.01	0.01	0.01	III, FL	3.5	1.0	0.80	0.70	0.36	0.22	0.11	0.05	-	-	-	-	-	-	-	-	-
RP 855	42	-55...200	0.1/0.01	0.01	0.01	III, FL	3.5	1.7	1.60	1.10	0.60	0.38	0.21	0.15	0.10	0.04	-	-	-	-	-	-	-
RP 870	42	-70...200	0.1/0.01	0.01	0.02	III, FL	3.5	0.5	0.38	0.36	0.33	0.30	0.25	-	0.25	-	0.20	0.10	-	-	-	-	-
RP 890	42	-90...200	0.1/0.01	0.01	0.02	III, FL	3.5	0.5	1.10	1.00	0.90	0.83	0.75	-	0.58	-	0.42	0.24	0.13	0.04	-	-	-
RP 1290	43	-88...200	0.1/0.01	0.01	0.02	III, FL	3.5	0.5	1.10	1.00	0.90	0.83	0.75	-	0.58	-	0.42	0.24	0.13	-	-	-	-
RP 1840	43	-40...200	0.1/0.01	0.01	0.01	III, FL	3.5	1.0	0.90	0.70	0.35	0.20	0.09	-	-	-	-	-	-	-	-	-	-
RP 1845	43	-50...200	0.1/0.01	0.01	0.01	III, FL	3.5	1.7	1.60	1.10	0.55	0.32	0.18	0.10	0.045	-	-	-	-	-	-	-	-
RP 3530	43	-35...200	0.1/0.01	0.01	0.02	III, FL	3.5	1.0	0.90	0.70	0.30	0.15	-	-	-	-	-	-	-	-	-	-	-
RP 845 C	44	-45...200	0.01	0.1/0.01/0.001	0.01	III, FL	3.5	1.0	0.80	0.70	0.36	0.22	0.11	0.05	-	-	-	-	-	-	-	-	-
RP 855 C	44	-55...200	0.01	0.1/0.01/0.001	0.01	III, FL	3.5	1.7	1.60	1.10	0.60	0.38	0.21	0.15	0.10	0.04	-	-	-	-	-	-	-
RP 870 C	44	-70...200	0.01	0.1/0.01/0.001	0.02	III, FL	3.5	0.5	0.38	0.36	0.33	0.30	0.25	-	0.25	-	0.20	0.10	-	-	-	-	-
RP 890 C	44	-90...200	0.01	0.1/0.01/0.001	0.02	III, FL	3.5	0.5	1.10	1.00	0.90	0.83	0.75	-	0.58	-	0.42	0.24	0.13	0.04	-	-	-
RP 1290 C	45	-88...200	0.01	0.1/0.01/0.001	0.02	III, FL	3.5	0.5	1.10	1.00	0.90	0.83	0.75	-	0.58	-	0.42	0.24	0.13	-	-	-	-
RP 1840 C	45	-40...200	0.01	0.1/0.01/0.001	0.01	III, FL	3.5	1.0	0.90	0.70	0.35	0.20	0.09	-	-	-	-	-	-	-	-	-	-
RP 1845 C	45	-50...200	0.01	0.1/0.01/0.001	0.01	III, FL	3.5	1.7	1.60	1.10	0.55	0.32	0.18	0.10	0.045	-	-	-	-	-	-	-	-
RP 3530 C	45	-35...200	0.01	0.1/0.01/0.001	0.02	III, FL	3.5	1.0	0.90	0.70	0.30	0.15	-	-	-	-	-	-	-	-	-	-	-

① At pump level 2 (ECO) and pump level 3 (Proline) ② III, FL: for use with flammable and non-flammable liquids; I, NFL: only for non-flammable liquids

Ⓢ Cooling output at -15 °C ③ Cooling output at -25 °C



Pump type®	Pump pressure max.	Pump suction max.	Pump flow max. (pressure)	Pump flow max. (suction)	Pump connection thread	Ø _e Nipples	Bath volume min.	Bath volume max.	Bath opening (WxD)	Bath depth	Usable depth	Height top of bath	Dimensions (WxDxH)	Weight	Power supply®	Loading	Cat. No.	Type
bar	bar	L/min	L/min	mm	mm	L	L	mm	mm	mm	mm	mm	kg	V; Hz	kW			
LAUDA Alpha																		
-	0.2	-	15	-	-	13	5.0	7.5	165x190	160	140	450	235x500x605	31.0	230; 50	1.8	LCKX 1907	RA 8
-	0.2	-	15	-	-	13	9.5	14.5	300x190	160	140	450	365x500x605	37.0	230; 50	1.8	LCKX 1908	RA 12
-	0.2	-	15	-	-	13	14.0	22.0	350x290	160	140	450	415x605x605	43.0	230; 50	1.8	LCKX 1909	RA 24

LAUDA ECO																		
V	0.55	-	22	-	-	13	3.3	4.0	130x105	160	140	365	180x350x546	19.6	230; 50	1.6	LCK 1910	RE 415 S
V	0.55	-	22	-	-	13	3.3	4.0	130x105	160	140	374	180x396x555	21.6	230; 50	1.6	LCK 1912	RE 420 S
V	0.55	-	22	-	-	13	4.6	5.7	150x130	160	140	400	200x430x581	23.3	230; 50	1.6	LCK 1914	RE 620 S
V	0.55	-	22	-	-	13	4.6	5.7	150x130	160	140	400	200x430x581	27.2	230; 50	1.7	LCK 1916	RE 630 S
V	0.55	-	22	-	-	13	8.0	10.0	200x200	160	140	443	280x440x624	34.6	230; 50	2.0	LCK 1918	RE 1050 S
V	0.55	-	22	-	-	13	9.3	12.0	200x200	200	180	443	250x435x624	30.0	230; 50	1.7	LCK 1920	RE 1225 S
V	0.55	-	22	-	-	13	14.0	20.0	300x350	160	140	443	350x570x624	37.0	230; 50	1.7	LCK 1922	RE 2025 S
V	0.55	-	22	-	M16x1	-	3.3	4.0	130x105	160	140	365	180x350x546	20.0	230; 50	2.8	LCK 1911	RE 415 G
V	0.55	-	22	-	M16x1	-	3.3	4.0	130x105	160	140	374	180x396x555	22.0	230; 50	2.8	LCK 1913	RE 420 G
V	0.55	-	22	-	M16x1	-	4.6	5.7	150x130	160	140	400	200x430x581	23.7	230; 50	2.8	LCK 1915	RE 620 G
V	0.55	-	22	-	M16x1	-	4.6	5.7	150x130	160	140	400	200x430x581	27.6	230; 50	2.8	LCK 1917	RE 630 G
V	0.55	-	22	-	M16x1	-	8.0	10.0	200x200	160	140	443	280x440x624	35.0	230; 50	3.3	LCK 1919	RE 1050 G
V	0.55	-	22	-	M16x1	-	9.3	12.0	200x200	200	180	443	250x435x624	30.4	230; 50	2.9	LCK 1921	RE 1225 G
V	0.55	-	22	-	M16x1	-	14.0	20.0	300x350	160	140	443	350x570x624	37.4	230; 50	2.9	LCK 1923	RE 2025 G
V	0.55	-	22	-	-	13	3.3	4.0	130x105	160	140	365	180x350x546	20.5	230; 50	1.6	LCK 1924	RE 415 SW
V	0.55	-	22	-	-	13	3.3	4.0	130x105	160	140	374	180x396x555	22.5	230; 50	1.6	LCK 1926	RE 420 SW
V	0.55	-	22	-	-	13	4.6	5.7	150x130	160	140	400	200x430x581	24.3	230; 50	1.6	LCK 1928	RE 620 SW
V	0.55	-	22	-	-	13	4.6	5.7	150x130	160	140	400	200x430x581	28.2	230; 50	1.7	LCK 1930	RE 630 SW
V	0.55	-	22	-	-	13	8.0	10.0	200x200	160	140	443	280x440x624	35.6	230; 50	2.0	LCK 1932	RE 1050 SW
V	0.55	-	22	-	-	13	9.3	12.0	200x200	200	180	443	250x435x624	31.2	230; 50	1.7	LCK 1934	RE 1225 SW
V	0.55	-	22	-	-	13	14.0	20.0	300x350	160	140	443	350x570x624	38.4	230; 50	1.7	LCK 1936	RE 2025 SW
V	0.55	-	22	-	M16x1	-	3.3	4.0	130x105	160	140	365	180x350x546	20.9	230; 50	2.8	LCK 1925	RE 415 GW
V	0.55	-	22	-	M16x1	-	3.3	4.0	130x105	160	140	374	180x396x555	22.9	230; 50	2.8	LCK 1927	RE 420 GW
V	0.55	-	22	-	M16x1	-	4.6	5.7	150x130	160	140	400	200x430x581	24.7	230; 50	2.8	LCK 1929	RE 620 GW
V	0.55	-	22	-	M16x1	-	4.6	5.7	150x130	160	140	400	200x430x581	28.6	230; 50	2.9	LCK 1931	RE 630 GW
V	0.55	-	22	-	M16x1	-	8.0	10.0	200x200	160	140	443	280x440x624	36.0	230; 50	3.3	LCK 1933	RE 1050 GW
V	0.55	-	22	-	M16x1	-	9.3	12.0	200x200	200	180	443	250x435x624	31.6	230; 50	2.9	LCK 1935	RE 1225 GW
V	0.55	-	22	-	M16x1	-	14.0	20.0	300x350	160	140	443	350x570x624	38.5	230; 50	2.9	LCK 1937	RE 2025 GW

LAUDA Proline																		
VF	0.7	0.4	25	23	M16x1	13	5.5	8.5	150x150	200	180	488	285x430x688	41.0	230; 50	3.6	LCK 1885	RP 845
VF	0.7	0.4	25	23	M16x1	13	5.5	8.5	150x150	200	180	570	400x540x770	60.0	230; 50	3.6	LCK 1893	RP 855
VF	0.7	0.4	25	23	M16x1	13	5.5	8.5	150x150	200	180	535	375x540x735	68.0	230; 50	3.6	LCK 1895	RP 870
VF	0.7	0.4	25	23	M16x1	13	5.5	8.0	150x150	200	180	535	495x615x735	100.0	230; 50	3.6	LCK 1897	RP 890
VF	0.7	0.4	25	23	M16x1	13	15.0	17.5	250x150	200	180	535	495x615x735	100.0	230; 50	3.6	LCK 1899	RP 1290
VF	0.7	0.4	25	23	M16x1	13	12.5	19.0	300x200	200	180	488	375x465x688	46.0	230; 50	3.6	LCK 1887	RP 1840
VF	0.7	0.4	25	23	M16x1	13	12.5	19.0	300x200	200	180	570	400x540x770	61.0	230; 50	3.6	LCK 1891	RP 1845
VF	0.7	0.4	25	23	M16x1	13	23.0	35.0	300x350	250	230	540	375x615x740	51.0	230; 50	3.6	LCK 1889	RP 3530
VF	0.7	0.4	25	23	M16x1	13	5.5	8.5	150x150	200	180	488	285x430x688®	41.0	230; 50	3.6	LCK 1886	RP 845 C
VF	0.7	0.4	25	23	M16x1	13	5.5	8.5	150x150	200	180	570	400x540x770®	60.0	230; 50	3.6	LCK 1894	RP 855 C
VF	0.7	0.4	25	23	M16x1	13	5.5	8.5	150x150	200	180	535	375x540x735®	68.0	230; 50	3.6	LCK 1896	RP 870 C
VF	0.7	0.4	25	23	M16x1	13	5.5	8.0	150x150	200	180	535	495x615x735®	100.0	230; 50	3.6	LCK 1898	RP 890 C
VF	0.7	0.4	25	23	M16x1	13	15.0	17.5	250x150	200	180	535	495x615x735®	100.0	230; 50	3.6	LCK 1900	RP 1290 C
VF	0.7	0.4	25	23	M16x1	13	12.5	19.0	300x200	200	180	488	375x465x688®	46.0	230; 50	3.6	LCK 1888	RP 1840 C
VF	0.7	0.4	25	23	M16x1	13	12.5	19.0	300x200	200	180	570	400x540x770®	61.0	230; 50	3.6	LCK 1892	RP 1845 C
VF	0.7	0.4	25	23	M16x1	13	23.0	35.0	300x350	250	230	540	375x615x740®	51.0	230; 50	3.6	LCK 1890	RP 3530 C

® D: pressure pump; V: Vario pump, pressure pump with 6 selectable output steps for ECO and 4 selectable output steps for Proline Kryomats; VF: Varioflex pump, pressure/suction pump with 8 selectable output steps ® Other power supply variants on page 99/100 ® With Command remote control: 56 mm higher

LAUDA Technical data according to DIN 12876 standard



Please note: all technical data from page 88 to 97 refer to the European power supply. Data for US-voltages are stated in the tables for technical data inside of the product line chapters as well as in the overview tables for power supply variants (pages 98 to 101). The differing data for cat. no., heater power and loading is included there as well.



Type	Page	Working temperature range (equal to ACC range) ①		Resolution of setting	Resolution of indication	Temperature stability	Safety fittings ②	Heater power		Effective cooling output ^① (measured with ethanol, 20 °C ambient temperature)												
		°C	°C					150 °C (thermal oil)	20 °C	0 °C	-20 °C	-30 °C	-40 °C	-45 °C	-50 °C	-55 °C	-60 °C	-70 °C	-80 °C	-90 °C		
LAUDA Proline Kryomats																						
RP 3050 C	48	-50...200	0.01	0.1/0.01/0.001	0.05	III, FL		3.5	5.00	5.00	3.00	1.60	1.00	0.50	-	0.25	-	-	-	-	-	-
RP 4050 C	48	-50...200	0.01	0.1/0.01/0.001	0.05	III, FL		3.5	5.00	5.00	3.00	1.60	1.00	0.50	-	0.25	-	-	-	-	-	-
RP 3090 C	48	-90...200	0.01	0.1/0.01/0.001	0.05	III, FL		3.5	3.00	3.00	2.90	2.50	2.30	2.00	-	1.60	-	1.30	0.80	0.50	0.15	
RP 4090 C	48	-90...200	0.01	0.1/0.01/0.001	0.05	III, FL		3.5	3.00	3.00	2.90	2.50	2.30	2.00	-	1.60	-	1.30	0.80	0.50	0.15	
RP 3050 CW	49	-50...200	0.01	0.1/0.01/0.001	0.05	III, FL		3.5	6.00	6.00	3.50	1.80	1.10	0.60	-	0.25	-	-	-	-	-	-
RP 4050 CW	49	-50...200	0.01	0.1/0.01/0.001	0.05	III, FL		3.5	6.00	6.00	3.50	1.80	1.10	0.60	-	0.25	-	-	-	-	-	-
RP 3090 CW	49	-90...200	0.01	0.1/0.01/0.001	0.05	III, FL		3.5	4.00	4.00	3.70	3.10	2.70	2.30	-	1.80	-	1.40	0.90	0.50	0.15	
RP 4090 CW	49	-90...200	0.01	0.1/0.01/0.001	0.05	III, FL		3.5	4.00	4.00	3.70	3.10	2.70	2.30	-	1.80	-	1.40	0.90	0.50	0.15	

Type	Page	Working temperature range (equal to ACC range)		Ambient temperature range	Resolution of setting	Resolution of indication	Control	Temperature stability	Heater power		Effective cooling output (measured with ethanol, 20 °C ambient temperature 15 °C water temperature and 3 bar water pressure)											
		°C	°C						°C	°C	±K	20 °C	10 °C	5 °C	0 °C	-5 °C	-10 °C	-15 °C	-20 °C	-25 °C	-30 °C	
LAUDA Integral T																						
T 1200	58	-25...120 ^③	5...40	0.1	0.05	↑ Proportional cooling with automatic refrigeration ↓	0.2	2.25	1.20	1.00	0.90	0.80	0.70	0.60	0.40	0.18	0.10	-				
T 1200 W	58	-25...120 ^③	5...40	0.1	0.05		0.2	2.25	1.60	1.30	1.20	1.10	0.85	0.70	0.45	0.25	0.10	-				
T 2200	58	-25...120 ^③	5...40	0.1	0.05		0.2	2.25	2.20	1.80	1.60	1.40	1.20	1.00	0.80	0.60	0.35	-				
T 2200 W	58	-25...120 ^③	5...40	0.1	0.05		0.2	2.25	2.70	2.30	2.10	1.90	1.70	1.40	1.00	0.68	0.42	-				
T 4600	59	-30...120 ^③	5...40	0.1	0.05		0.2	6	4.60	3.70	3.20	2.80	2.30	1.90	1.30	1.00	0.50	0.20				
T 4600 W	59	-30...120 ^③	5...40	0.1	0.05		0.2	6	5.50	4.50	4.00	3.40	2.90	2.30	1.70	1.10	0.65	0.30				
T 7000	59	-30...120 ^③	5...40	0.1	0.05		0.3	6	7.00	6.00	5.50	5.00	4.00	3.00	2.40	1.70	1.00	0.50				
T 7000 W	59	-30...120 ^③	5...40	0.1	0.05		0.3	6	8.50	7.00	6.30	5.50	4.70	3.90	3.00	2.00	1.30	0.60				
T 10000	59	-30...120 ^③	5...40	0.1	0.05		0.3	9	10.00	9.00	8.20	7.30	6.20	5.10	4.10	3.00	2.20	1.20				
T 10000 W	59	-30...120 ^③	5...40	0.1	0.05		0.3	9	13.00	11.00	9.90	8.70	7.40	6.00	4.90	3.70	2.60	1.50				

Type	Page	Working temperature range (equal to ACC range)		Ambient temperature range	Resolution of setting	Compressor cooling	Temperature stability	Heater power		Effective cooling output (measured with pump step 4 at 20 °C ambient temperature/ 15 °C water temperature and 3 bar water pressure)												
		°C	°C					°C	±K	300 °C with thermal oil	200 °C with thermal oil	100 °C with thermal oil	20 °C with thermal oil	10 °C with ethanol	0 °C with ethanol	-10 °C with ethanol	-20 °C with ethanol	-30 °C with ethanol	-40 °C with ethanol	-50 °C with ethanol	-60 °C with ethanol	-70 °C with ethanol
LAUDA Integral XT																						
XT 150	62	-45...200	5...40	0.01	Air	0.05	3.5	-	1.50 ^④	1.50 ^④	1.50 ^④	1.30 ^④	1.10 ^④	1.00 ^④	0.62 ^④	0.28 ^④	0.06 ^④	-	-	-	-	
XT 280	62	-80...200	5...40	0.01	Air	0.10	4.0	-	1.50	1.50	1.50	1.50	1.40	1.40	1.30	1.30	1.30	1.20	1.00	0.40	0.10	-
XT 750	62	-50...200	5...40	0.01	Air	0.05	5.3	-	7.00	7.00	6.70	6.10	4.80	3.40	2.20	1.25	0.60 ^④	0.30 ^④	-	-	-	-
XT 750 H	62	-50...300	5...40	0.01	Air	0.05	5.3	5.5	7.00	7.00	6.70	6.10	4.80	3.40	2.20	1.25	0.60 ^④	0.30 ^④	-	-	-	-
XT 250 W	63	-45...200	5...40	0.01	Water	0.05	3.5	-	2.10 ^④	2.10 ^④	2.10 ^④	1.80 ^④	1.30 ^④	1.00 ^④	0.62 ^④	0.28 ^④	0.06 ^④	-	-	-	-	
XT 350 W	63	-50...200	5...40	0.01	Water	0.10	3.5	-	3.10	3.10	3.10	3.10	3.10	2.00	1.20	0.70	0.25 ^④	0.02	-	-	-	-
XT 350 HW	63	-50...300	5...40	0.01	Water	0.10	3.5	12	12.00	6.00	3.10	3.10	3.10	2.00	1.20	0.70	0.25 ^④	0.02 ^④	-	-	-	-
XT 950 W	64	-50...200	5...40	0.01	Water	0.10	5.3	-	9.00	9.00	9.00	7.50	6.60	4.60	3.00	1.70	0.90 ^④	0.35 ^④	-	-	-	-
XT 1850 W	64	-50...200	5...40	0.01	Water	0.30	10.6	-	18.50	18.50	18.50	12.50	10.30	7.70	5.90	3.80	2.20 ^④	1.20 ^④	-	-	-	-
XT 1850 WS	64	-50...200	5...40	0.01	Water	0.30	16.0	-	18.50	18.50	18.50	12.50	10.30	7.70	5.90	3.80	2.20 ^④	1.20 ^④	-	-	-	-
XT 490 W	64	-90...200	5...40	0.01	Water	0.10	5.3	-	4.40	4.40	4.40	4.40	4.40	4.40	4.40	4.40	4.00	3.30	2.30	1.35	0.70 ^④	0.20 ^④
XT 1590 W	64	-90...200	5...40	0.01	Water	0.30	5.3	-	15.00	15.00	15.00	13.00	10.50	9.20	8.50	8.50	7.00	5.30	3.70	1.80	0.90 ^④	0.35 ^④

① On pump output step 6 ② III, FL: for use with flammable and non-flammable liquids ③ Optional up to 150 °C ④ On pump output step 2



Pump type®	Pump pressure max.	Pump suction max.	Pump flow max.	Pump flow max. (pressure)	Pump connection thread	Ø Nipples	Bath volume min.	Bath volume max.	Bath opening (WxD)	Bath depth	Usable depth	Height top of bath	Dimensions (WxDxH)	Weight	Power supply®	Loading	Cat. No.	Type
bar	bar	L/min	L/min	mm	mm	L	L	mm	mm	mm	mm	mm	mm	kg	V; Hz	kW		
LAUDA Proline Kryomats																		
V	0.5	–	19	–	M16x1	13	23.0	31.0	350x200	250	230	905	600x700x1160 [®]	130.0	400; 3/N/PE; 50	5.0	LUK 239	RP 3050 C
V	0.5	–	19	–	M16x1	13	32.0	44.0	350x350	250	230	905	600x700x1160 [®]	130.0	400; 3/N/PE; 50	5.0	LUK 241	RP 4050 C
V	0.5	–	19	–	M16x1	13	23.0	31.0	350x200	250	230	905	600x700x1160 [®]	155.0	400; 3/N/PE; 50	5.0	LUK 245	RP 3090 C
V	0.5	–	19	–	M16x1	13	32.0	44.0	350x350	250	230	905	600x700x1160 [®]	155.0	400; 3/N/PE; 50	5.0	LUK 247	RP 4090 C
V	0.5	–	19	–	M16x1	13	23.0	31.0	350x200	250	230	905	600x700x1160 [®]	130.0	400; 3/N/PE; 50	5.0	LUK 240	RP 3050 CW
V	0.5	–	19	–	M16x1	13	32.0	44.0	350x350	250	230	905	600x700x1160 [®]	130.0	400; 3/N/PE; 50	5.0	LUK 242	RP 4050 CW
V	0.5	–	19	–	M16x1	13	23.0	31.0	350x200	250	230	905	600x700x1160 [®]	155.0	400; 3/N/PE; 50	5.0	LUK 246	RP 3090 CW
V	0.5	–	19	–	M16x1	13	32.0	44.0	350x350	250	230	905	600x700x1160 [®]	155.0	400; 3/N/PE; 50	5.0	LUK 248	RP 4090 CW

Pump pressure max.	Pump flow max.	Pump connection thread	For tubing	Filling volume	Dimensions (WxDxH)	Pressure measurement/parameter	Protection level	Noise level	Additional features	Weight	Loading	Power supply®	Cat. No.	Type
bar	L/min	i. d. (mm)		L	mm			dB(A)		kg	kW	V; Hz		
LAUDA Integral T														
3.2	40	G ^{3/4} /(15)	3/4"	3...7	450x550x790	↑	IP 32	60	↑	77	2.7	230; 50	LWP 101	T 1200
3.2	40	G ^{3/4} /(15)	3/4"	3...7	450x550x790	↑	IP 32	58	Level indication	82	2.7	230; 50	LWP 102	T 1200 W
3.2	40	G ^{3/4} /(15)	3/4"	3...7	450x550x790	↑	IP 32	60	↓	89	3.1	230; 50	LWP 103	T 2200
3.2	40	G ^{3/4} /(15)	3/4"	3...7	450x550x790	↑	IP 32	58	↓	94	3.1	230; 50	LWP 104	T 2200 W
3.2	40	G ^{3/4} /(15)	3/4"	6...18	550x650x970	Digital/Bypass	IP 32	63	↑	123	8.5	400; 3/N/PE; 50	LWP 205	T 4600
3.2	40	G ^{3/4} /(15)	3/4"	6...18	550x650x970	↓	IP 32	61	Level indication, additional pump for internal circulation	128	8.3	400; 3/N/PE; 50	LWP 206	T 4600 W
6.0	60	G1 ^{1/4} /(20)	1"	8...20	850x670x970	↓	IP 32	65	↓	175	11.5	400; 3/N/PE; 50	LWP 207	T 7000
6.0	60	G1 ^{1/4} /(20)	1"	8...20	850x670x970	↓	IP 32	63	↓	180	11.2	400; 3/N/PE; 50	LWP 208	T 7000 W
6.0	60	G1 ^{1/4} /(20)	1"	8...20	1050x770x1120	↓	IP 32	69	↓	235	16.0	400; 3/N/PE; 50	LWP 209	T 10000
6.0	60	G1 ^{1/4} /(20)	1"	8...20	850x670x970	↓	IP 32	67	↓	242	15.5	400; 3/N/PE; 50	LWP 210	T 10000 W

Pump pressure max.	Pump flow max.	Pump connection thread	Filling volume min.	Filling volume expansion vessel	Dimensions (WxDxH)	Pressure measurement/parameter	Protection level	Additional features	Weight	Loading	Power supply®	Cat. No.	Type
bar	L/min	i. d. (mm)	L	L	mm				kg	kW	V; Hz		
LAUDA Integral XT													
2.9	45	M30 x 1.5 (DN 20)	2.6	5.5	335x550x660	digital	IP21C	Level indication	87	3.68	230; 50	LWP 112	XT 150
2.9	45	M30 x 1.5 (DN 20)	5.3	6.7	460x550x1285	digital	IP21C	Level indication	200	9.00	400; 3/PE; 50	LWP 534	XT 280
2.9	45	M30 x 1.5 (DN 20)	5.0	6.7	460x550x1285	digital	IP21C	Level indication	155	7.80	400; 3/PE; 50	LWP 520	XT 750
2.9	45	M30 x 1.5 (DN 20)	5.3	6.7	460x550x1285	digital	IP21C	Level indication	160	7.80	400; 3/PE; 50	LWP 522	XT 750 H
2.9	45	M30 x 1.5 (DN 20)	2.6	5.5	335x550x660	digital	IP21C	Level indication	90	3.68	230; 50	LWP 113	XT 250 W
2.9	45	M30 x 1.5 (DN 20)	5.0	6.7	460x550x1285	digital	IP21C	Level indication	150	3.68	230; 50	LWP 117	XT 350 W
2.9	45	M30 x 1.5 (DN 20)	5.0	6.7	460x550x1285	digital	IP21C	Level indication	150	3.68	230; 50	LWP 119	XT 350 HW
2.9	45	M30 x 1.5 (DN 20)	5.0	6.7	460x550x1285	digital	IP21C	Level indication	160	7.80	400; 3/PE; 50	LWP 521	XT 950 W
5.8	90	M38 x 1.5 (DN 25)	9.0	17.4	700x550x1600	digital	IP21C	Level indication	250	13.80	400; 3/PE; 50	LWP 532	XT 1850 W
5.8	90	M38 x 1.5 (DN 25)	9.0	17.4	700x550x1600	digital	IP21C	Level indication	250	17.30	400; 3/PE; 50	LWP 533	XT 1850 WS
2.9	45	M30 x 1.5 (DN 20)	9.5	17.4	700x550x1600	digital	IP21C	Level indication	245	9.00	400; 3/PE; 50	LWP 539	XT 490 W
2.9	45	M30 x 1.5 (DN 20)	10.5	17.4	700x550x1600	digital	IP21C	Level indication	280	13.80	400; 3/PE; 50	LWP 542	XT 1590 W

® Other power supply variants on page 100

® V: Vario pump, pressure pump with 4 selectable output steps for Proline Kryomats

® With Command remote control: 56 mm higher

LAUDA Technical data according to DIN 12876 standard



Please note: all technical data from page 88 to 97 refer to the European power supply. Data for US-voltages are stated in the tables for technical data inside of the product line chapters as well as in the overview tables for power supply variants (pages 98 to 101). The differing data for cat. no., heater power and loading is included there as well.

Technical data

Type	Page	Working temperature range (equal to ACC range)		Ambient temperature range	Resolution of setting	Resolution of indication	Control	Temperature stability	Cooling output (measured with ethanol, 20 °C ambient temperature)											Heater power
		°C	°C						±K	20 °C	10 °C	5 °C	0 °C	-5 °C	-10 °C	-15 °C	-20 °C	-25 °C	-30 °C	
LAUDA WK class																				
WK 300	70	0...40	5...35	0.1/1	0.1			0.5	0.31	0.25	0.21	0.17	-	-	-	-	-			
WK 500	70	0...40	5...40	0.1	0.1			0.5	0.50	0.30	0.18	0.05	-	-	-	-	-			
WK 502	70	0...40	5...40	0.1	0.1			0.5	0.60	0.50	0.40	0.30	-	-	-	-	-			
WK 1200	71	0...40	5...40	0.1	0.1			0.5	1.20	0.90	0.60	0.28	-	-	-	-	-			
WK 1200 W	71	0...40	5...40	0.1	0.1			0.5	1.50	1.10	0.80	0.32	-	-	-	-	-			
WK 1400	71	0...40	5...40	0.1	0.1			0.5	1.40	1.10	0.80	0.50	-	-	-	-	-			
WK 1400 W	71	0...40	5...40	0.1	0.1		Compressor on/off	0.5	1.70	1.30	1.00	0.70	-	-	-	-	-			
WK 2200	71	0...40	5...40	0.1	0.1			1	2.20	1.60	1.20	0.80	-	-	-	-	-			
WK 2200 W	71	0...40	5...40	0.1	0.1			1	2.60	1.90	1.50	1.00	-	-	-	-	-			
WK 2400	71	0...40	5...40	0.1	0.1			1	2.40	1.80	1.40	1.00	-	-	-	-	-			
WK 2400 W	71	0...40	5...40	0.1	0.1			1	2.80	2.10	1.70	1.20	-	-	-	-	-			
WK 3200	72	0...40	5...40	0.1	0.1			1	3.50	3.00	2.30	1.20	-	-	-	-	-			
WK 3200 W	72	0...40	5...40	0.1	0.1			1	4.00	3.50	2.60	1.50	-	-	-	-	-			
WK 4600	72	0...40	5...40	0.1	0.1			0.5	4.60	3.40	2.30	1.20	-	-	-	-	-			
WK 4600 W	72	0...40	5...40	0.1	0.1			0.5	5.30	4.00	2.60	1.50	-	-	-	-	-			
WK 7000	72	0...40	5...40	0.1	0.1			0.5	7.00	6.00	5.50	5.00	-	-	-	-	-			
WK 7000 W	72	0...40	5...40	0.1	0.1		Solenoid valve counter acting	0.5	8.50	7.00	6.30	5.50	-	-	-	-	-			
WK 10000	72	0...40	5...40	0.1	0.1			0.5	10.00	9.00	8.20	7.30	-	-	-	-	-			
WK 10000 W	72	0...40	5...40	0.1	0.1			0.5	13.00	11.00	9.90	8.70	-	-	-	-	-			
WKL 230	73	-10...40	5...35	0.1/1	0.1/1*			0.5	0.23	0.19	0.18	0.16	0.13	0.10	-	-	-			
WKL 600	73	-25...40	5...40	0.1/1	0.1/1*			1	0.65	0.55	0.49	0.43	0.38	0.33	-	0.20	0.12			
WKL 603	73	-20...40	5...40	0.1/1	0.1/1*			1	0.52	0.42	0.37	0.30	0.25	0.20	0.13	0.07	-			
WKL 900	73	-20...40	5...40	0.1/1	0.1/1*			1	0.95	0.84	0.74	0.64	0.52	0.40	0.28	0.15	-			
WKL 903	73	-15...40	5...40	0.1/1	0.1/1*		Compressor on/off	1	0.80	0.70	0.60	0.50	0.38	0.26	0.13	-	-			
WKL 1000	73	-10...40	5...40	0.1/1	0.1/1*			0.5	1.00	0.80	0.66	0.51	0.38	0.24	-	-	-			
WKL 1200	74	-10...40	5...40	0.1/1	0.1/1*			0.5	1.20	1.00	0.90	0.80	0.70	0.60	0.40**	0.18**	0.10**			
WKL 1200 W	74	-10...40	5...40	0.1/1	0.1/1*			0.5	1.60	1.30	1.20	1.10	0.85	0.70	0.45**	0.25**	0.10**			
WKL 2200	74	-10...40	5...40	0.1/1	0.1/1*			1	2.20	1.80	1.60	1.40	1.20	1.00	0.80**	0.60**	0.35**			
WKL 2200 W	74	-10...40	5...40	0.1/1	0.1/1*			1	2.70	2.30	2.10	1.90	1.70	1.40	1.00**	0.68**	0.42**			
WKL 3200	74	-10...40	5...40	0.1/1	0.1/1*			1	3.50	2.80	2.40	2.00	1.70	1.30	1.00**	0.60**	0.30**			
WKL 3200 W	74	-10...40	5...40	0.1/1	0.1/1*			1	4.20	3.30	2.90	2.20	1.80	1.40	1.10**	0.70**	0.40**			
WKL 4600	74	-10...40	5...40	0.1/1	0.1/1*			0.5	4.60	3.70	3.20	2.40	1.90	1.50	1.10**	0.70**	0.40**			
WKL 4600 W	74	-10...40	5...40	0.1/1	0.1/1*		Solenoid valve counter acting	0.5	5.30	4.20	3.60	2.80	2.20	1.70	1.20**	0.80**	0.50**			
WKL 7000	74	-30...40	5...40	0.1/1	0.1/1*			0.5	7.00	6.00	5.50	5.00	4.00	3.00	2.40	1.70	1.00			
WKL 7000 W	74	-30...40	5...40	0.1/1	0.1/1*			0.5	8.50	7.00	6.30	5.50	4.70	3.90	3.00	2.00	1.30			
WKL 10000	74	-30...40	5...40	0.1/1	0.1/1*			0.5	10.00	9.00	8.20	7.30	6.20	5.10	4.10	3.00	2.20			
WKL 10000 W	74	-30...40	5...40	0.1/1	0.1/1*			0.5	13.00	11.00	9.90	8.70	7.40	6.00	4.90	3.70	2.60			



Pump pressure max.	Pump flow max. (pressure)	Pump connection thread (inner diameter in mm)	For tubings	Filling volume	Dimensions (WxDxH)	Pressure measurement parameter	Protection level	Noise level	Additional features	Weight	Loading	Power supply	Cat. No.	Type
bar	L/min	i. d. (mm)	L	mm				dB(A)		kg	kW	V; Hz		
LAUDA WK class														
0.15	8	Ø 10 mm	8...9 mm	4...6	200x350x500	No	IP 32	47		24	0.35	230; 50	LWM 117	WK 300
1.0	30	M16x1/(10)	1/2"	8...12	350x480x595	No	IP 32	50		46	0.47	230; 50	LWG 132	WK 500
2.2	33	M16x1/(10)	1/2"	8...12	350x480x715	No	IP 32	55		50	0.9	230; 50	LWG 140	WK 502
3.2	40	G3/4/(15)	3/4"	16...23	450x550x790		IP 32	59		75	1.2	230; 50	LWG 133	WK 1200
3.2	40	G3/4/(15)	3/4"	16...23	450x550x790		IP 32	57		75	1.2	230; 50	LWG 161	WK 1200 W
1.0	30	G3/4/(15)	3/4"	16...23	450x550x790		IP 32	56		69	1.0	230; 50	LWG 137	WK 1400
1.0	30	G3/4/(15)	3/4"	16...23	450x550x790		IP 32	54		69	1.0	230; 50	LWG 162	WK 1400 W
3.2	40	G3/4/(15)	3/4"	16...23	450x550x790		IP 32	59	Level indication	87	1.6	230; 50	LWG 134	WK 2200
3.2	40	G3/4/(15)	3/4"	16...23	450x550x790		IP 32	57		87	1.6	230; 50	LWG 163	WK 2200 W
1.0	30	G3/4/(15)	3/4"	16...23	450x550x790		IP 32	57		81	1.4	230; 50	LWG 138	WK 2400
1.0	30	G3/4/(15)	3/4"	16...23	450x550x790		IP 32	55		81	1.4	230; 50	LWG 164	WK 2400 W
3.2	40	G3/4/(15)	3/4"	32...45	550x650x970	Analogue/ Bypass	IP 32	62		120	2.0	400; 3/N/PE; 50	LWG 235	WK 3200
3.2	40	G3/4/(15)	3/4"	32...45	550x650x970		IP 32	62		120	2.0	400; 3/N/PE; 50	LWG 265	WK 3200 W
3.2	40	G3/4/(15)	3/4"	32...45	550x650x970		IP 32	63		123	2.5	400; 3/N/PE; 50	LWG 236	WK 4600
3.2	40	G3/4/(15)	3/4"	32...45	550x650x970		IP 32	63		128	2.3	400; 3/N/PE; 50	LWG 258	WK 4600 W
3.2	40	G3/4/(15)	3/4"	32...45	850x670x970		IP 32	65		172	5.0	400; 3/N/PE; 50	LWG 245	WK 7000
3.2	40	G3/4/(15)	3/4"	32...45	850x670x970		IP 32	63	Level indication, additional pump for internal circulation	177	4.7	400; 3/N/PE; 50	LWG 247	WK 7000 W
3.2	40	G3/4/(15)	3/4"	32...45	1050x770x1120		IP 32	69		233	6.5	400; 3/N/PE; 50	LWG 249	WK 10000
3.2	40	G3/4/(15)	3/4"	32...45	850x670x970		IP 32	67		240	6.0	400; 3/N/PE; 50	LWG 251	WK 10000 W
0.15	8	Ø 10mm	8...9 mm	4...6	200x350x500	No	IP 32	47		24	0.3	230; 50/60	LWM 016	WKL 230
1.0	30	M16x1/(10)	1/2"	8...12	350x480x595	No	IP 32	53		46	0.7	230; 50	LWG 141	WKL 600
3.2	33	M16x1/(10)	1/2"	8...12	350x480x715	No	IP 32	57		50	0.9	230; 50	LWG 142	WKL 603
1.0	30	M16x1/(10)	1/2"	8...12	350x480x595	No	IP 32	54		46	0.8	230; 50	LWG 159	WKL 900
3.2	33	M16x1/(10)	1/2"	8...12	350x480x715	No	IP 32	57		50	1.0	230; 50	LWG 160	WKL 903
1.0	30	M16x1/(10)	1/2"	8...12	350x480x595	No	IP 32	50		46	1.1	230; 50	LWG 173	WKL 1000
3.2	40	G3/4/(15)	3/4"	16...23	450x550x790		IP 32	60	Level indication	75	1.6	230; 50	LWG 153	WKL 1200
3.2	40	G3/4/(15)	3/4"	16...23	450x550x790		IP 32	58		75	1.6	230; 50	LWG 166	WKL 1200 W
3.2	40	G3/4/(15)	3/4"	16...23	450x550x790		IP 32	60		69	2.2	230; 50	LWG 154	WKL 2200
3.2	40	G3/4/(15)	3/4"	16...23	450x550x790		IP 32	58		69	2.2	230; 50	LWG 167	WKL 2200 W
3.2	40	G3/4/(15)	3/4"	32...45	550x650x970		IP 32	62		120	2.8	400; 3/N/PE; 50	LWG 255	WKL 3200
3.2	40	G3/4/(15)	3/4"	32...45	550x650x970	Analogue/ Bypass	IP 32	62		120	2.8	400; 3/N/PE; 50	LWG 268	WKL 3200 W
3.2	40	G3/4/(15)	3/4"	32...45	550x650x970		IP 32	63		123	3.5	400; 3/N/PE; 50	LWG 256	WKL 4600
3.2	40	G3/4/(15)	3/4"	32...45	550x650x970		IP 32	61		130	3.3	400; 3/N/PE; 50	LWG 257	WKL 4600 W
6.0	60	G1 1/4/(20)	1"	32...45	850x670x970		IP 32	65		175	5.5	400; 3/N/PE; 50	LWG 246	WKL 7000
6.0	60	G1 1/4/(20)	1"	32...45	850x670x970		IP 32	63	Level indication, additional pump for internal circulation	180	5.2	400; 3/N/PE; 50	LWG 248	WKL 7000 W
6.0	60	G1 1/4/(20)	1"	32...45	1050x770x1120		IP 32	69		235	7.0	400; 3/N/PE; 50	LWG 250	WKL 10000
6.0	60	G1 1/4/(20)	1"	32...45	850x670x970		IP 32	67		242	6.5	400; 3/N/PE; 50	LWG 252	WKL 10000 W

LAUDA Power supply variants



Type	Cat. No.	Heater power kW	Loading kW	Cat. No.	Heater power kW	Loading kW	Cat. No.	Heater power kW	Loading kW
230 V; 50/60 Hz									
LAUDA Aqualine – single phase									
AL 2	LCB 0723	0.5	0.6	LCB 4723	0.45	0.6	LCB 6723	0.34	0.5
AL 5	LCB 0724	0.5	0.6	LCB 4724	0.45	0.6	LCB 6724	0.34	0.5
AL 12	LCB 0725	1.0	1.1	LCB 4725	1.0	1.1	LCB 6725	0.76	0.9
AL 18	LCB 0726	1.2	1.3	LCB 4726	1.2	1.3	LCB 6726	0.9	1.0
AL 25	LCB 0727	1.2	1.3	LCB 4727	1.2	1.3	LCB 6727	0.9	1.0
115 V; 60 Hz									
LAUDA Alpha – single phase									
A	LCEX 0226	1.5	1.5	LCEX 4226	1.15	1.2	LCEX 6226	1.0	1.0
A 6	LCBX 0733	1.5	1.5	LCBX 4733	1.15	1.2	LCBX 6733	1.0	1.0
A 12	LCBX 0734	1.5	1.5	LCBX 4734	1.15	1.2	LCBX 6734	1.0	1.0
A 24	LCBX 0735	1.5	1.5	LCBX 4735	1.15	1.2	LCBX 6735	1.0	1.0

Cat. No.
Heater power kW
Loading kW

230 V; 50/60 Hz				220 V; 60 Hz				115 V; 60 Hz				100 V; 50/60 Hz													
LAUDA ECO – single phase																									
Silver	LCE 0227	1.3	1.4	LCE 2227	1.2	1.3	LCE 4227	1.3	1.4	LCE 6227	1.0	1.1	LCE 2228	2.4	2.5	LCE 4228	1.3	1.4	LCE 6228	1.0	1.1				
Gold	LCE 0228	2.6	2.7	LCE 2228	2.4	2.5	LCE 4228	1.3	1.4	LCE 6228	1.0	1.1	LCB 2736	1.2	1.3	LCB 4736	1.3	1.4	LCB 6736	1.0	1.1				
E 4 S	LCB 0736	1.3	1.4	LCB 2736	1.2	1.3	LCB 4736	1.3	1.4	LCB 6736	1.0	1.1	E 10 S	LCB 0738	1.3	1.4	LCB 2738	1.2	1.3	LCB 4738	1.3	1.4	LCB 6738	1.0	1.1
E 15 S	LCB 0740	1.3	1.4	LCB 2740	1.2	1.3	LCB 4740	1.3	1.4	LCB 6740	1.0	1.1	E 20 S	LCB 0742	1.3	1.4	LCB 2742	1.2	1.3	LCB 4742	1.3	1.4	LCB 6742	1.0	1.1
E 20 S	LCB 0742	1.3	1.4	LCB 2742	1.2	1.3	LCB 4742	1.3	1.4	LCB 6742	1.0	1.1	E 25 S	LCB 0744	1.3	1.4	LCB 2744	1.2	1.3	LCB 4744	1.3	1.4	LCB 6744	1.0	1.1
E 25 S	LCB 0744	1.3	1.4	LCB 2744	1.2	1.3	LCB 4744	1.3	1.4	LCB 6744	1.0	1.1	E 40 S	LCB 0746	1.3	1.4	LCB 2746	1.2	1.3	LCB 4746	1.3	1.4	LCB 6746	1.0	1.1
E 40 S	LCB 0746	1.3	1.4	LCB 2746	1.2	1.3	LCB 4746	1.3	1.4	LCB 6746	1.0	1.1	E 4 G	LCB 0737	2.6	2.7	LCB 2737	2.4	2.5	LCB 4737	1.3	1.4	LCB 6737	1.0	1.1
E 4 G	LCB 0737	2.6	2.7	LCB 2737	2.4	2.5	LCB 4737	1.3	1.4	LCB 6737	1.0	1.1	E 10 G	LCB 0739	2.6	2.7	LCB 2739	2.4	2.5	LCB 4739	1.3	1.4	LCB 6739	1.0	1.1
E 10 G	LCB 0739	2.6	2.7	LCB 2739	2.4	2.5	LCB 4739	1.3	1.4	LCB 6739	1.0	1.1	E 15 G	LCB 0741	2.6	2.7	LCB 2741	2.4	2.5	LCB 4741	1.3	1.4	LCB 6741	1.0	1.1
E 15 G	LCB 0741	2.6	2.7	LCB 2741	2.4	2.5	LCB 4741	1.3	1.4	LCB 6741	1.0	1.1	E 20 G	LCB 0743	2.6	2.7	LCB 2743	2.4	2.5	LCB 4743	1.3	1.4	LCB 6743	1.0	1.1
E 20 G	LCB 0743	2.6	2.7	LCB 2743	2.4	2.5	LCB 4743	1.3	1.4	LCB 6743	1.0	1.1	E 25 G	LCB 0745	2.6	2.7	LCB 2745	2.4	2.5	LCB 4745	1.3	1.4	LCB 6745	1.0	1.1
E 25 G	LCB 0745	2.6	2.7	LCB 2745	2.4	2.5	LCB 4745	1.3	1.4	LCB 6745	1.0	1.1	E 40 G	LCB 0747	2.6	2.7	LCB 2747	2.4	2.5	LCB 4747	1.3	1.4	LCB 6747	1.0	1.1
E 40 G	LCB 0747	2.6	2.7	LCB 2747	2.4	2.5	LCB 4747	1.3	1.4	LCB 6747	1.0	1.1	ET 6 S	LCM 0096	1.3	1.4	LCM 2096	1.2	1.3	LCM 4096	1.3	1.4	LCM 6096	1.0	1.1
ET 6 S	LCM 0096	1.3	1.4	LCM 2096	1.2	1.3	LCM 4096	1.3	1.4	LCM 6096	1.0	1.1	ET 12 S	LCD 0286	1.3	1.4	LCD 2286	1.2	1.3	LCD 4286	1.3	1.4	LCD 6286	1.0	1.1
ET 12 S	LCD 0286	1.3	1.4	LCD 2286	1.2	1.3	LCD 4286	1.3	1.4	LCD 6286	1.0	1.1	ET 15 S	LCD 0288	1.3	1.4	LCD 2288	1.2	1.3	LCD 4288	1.3	1.4	LCD 6288	1.0	1.1
ET 15 S	LCD 0288	1.3	1.4	LCD 2288	1.2	1.3	LCD 4288	1.3	1.4	LCD 6288	1.0	1.1	ET 20 S	LCD 0290	1.3	1.4	LCD 2290	1.2	1.3	LCD 4290	1.3	1.4	LCD 6290	1.0	1.1
ET 20 S	LCD 0290	1.3	1.4	LCD 2290	1.2	1.3	LCD 4290	1.3	1.4	LCD 6290	1.0	1.1	ET 6 G	LCM 0097	2.6	2.7	LCM 2097	2.4	2.5	LCM 4097	1.3	1.4	LCM 6097	1.0	1.1
ET 6 G	LCM 0097	2.6	2.7	LCM 2097	2.4	2.5	LCM 4097	1.3	1.4	LCM 6097	1.0	1.1	ET 12 G	LCD 0287	2.6	2.7	LCD 2287	2.4	2.5	LCD 4287	1.3	1.4	LCD 6287	1.0	1.1
ET 12 G	LCD 0287	2.6	2.7	LCD 2287	2.4	2.5	LCD 4287	1.3	1.4	LCD 6287	1.0	1.1	ET 15 G	LCD 0289	2.6	2.7	LCD 2289	2.4	2.5	LCD 4289	1.3	1.4	LCD 6289	1.0	1.1
ET 15 G	LCD 0289	2.6	2.7	LCD 2289	2.4	2.5	LCD 4289	1.3	1.4	LCD 6289	1.0	1.1	ET 20 G	LCD 0291	2.6	2.7	LCD 2291	2.4	2.5	LCD 4291	1.3	1.4	LCD 6291	1.0	1.1
ET 20 G	LCD 0291	2.6	2.7	LCD 2291	2.4	2.5	LCD 4291	1.3	1.4	LCD 6291	1.0	1.1													

Cat. No.
Heater power kW
Loading kW

230 V; 50/60 Hz				115 V; 60 Hz				100 V; 50/60 Hz				200 V; 50/60 Hz				208-220 V; 60 Hz			
LAUDA Proline – single phase																			
P 5	LCB 0708	3.5	3.6	LCB 4708	1.8	1.8	LCB 6708	1.4	1.4	LCB 5708	2.8	2.9	LCB 8708	3.5	3.6	LCB 8708	3.5	3.6	
P 8	LCB 0710	3.5	3.6	LCB 4710	1.8	1.8	LCB 6710	1.4	1.4	LCB 5710	2.8	2.9	LCB 8710	3.5	3.6	LCB 8710	3.5	3.6	
P 12	LCB 0716	3.5	3.6	LCB 4716	1.8	1.8	LCB 6716	1.4	1.4	LCB 5716	2.8	2.9	LCB 8716	3.5	3.6	LCB 8716	3.5	3.6	
P 18	LCB 0712	3.5	3.6	LCB 4712	1.8	1.8	LCB 6712	1.4	1.4	LCB 5712	2.8	2.9	LCB 8712	3.5	3.6	LCB 8712	3.5	3.6	
P 26	LCB 0714	3.5	3.6	LCB 4714	1.8	1.8	LCB 6714	1.4	1.4	LCB 5714	2.8	2.9	LCB 8714	3.5	3.6	LCB 8714	3.5	3.6	
P 40	LCB 0728	3.5	3.6	–	–	–	–	–	–	–	–	LCB 8728	3.5	3.6	LCB 8728	3.5	3.6		
P 50	LCB 0730	3.5	3.6	–	–	–	–	–	–	–	–	LCB 8730	3.5	3.6	LCB 8730	3.5	3.6		
P 5 C	LCB 0709	3.5	3.6	LCB 4709	1.8	1.8	LCB 6709	1.4	1.4	LCB 5709	2.8	2.9	LCB 8709	3.5	3.6	LCB 8709	3.5	3.6	
P 8 C	LCB 0711	3.5	3.6	LCB 4711	1.8	1.8	LCB 6711	1.4	1.4	LCB 5711	2.8	2.9	LCB 8711	3.5	3.6	LCB 8711	3.5	3.6	
P 12 C	LCB 0717	3.5	3.6	LCB 4717	1.8	1.8	LCB 6717	1.4	1.4	LCB 5717	2.8	2.9	LCB 8717	3.5	3.6	LCB 8717	3.5	3.6	
P 18 C	LCB 0713	3.5	3.6	LCB 4713	1.8	1.8	LCB 6713	1.4	1.4	LCB 5713	2.8	2.9	LCB 8713	3.5	3.6	LCB 8713	3.5	3.6	
P 26 C	LCB 0715	3.5	3.6	LCB 4715	1.8	1.8	LCB 6715	1.4	1.4	LCB 5715	2.8	2.9	LCB 8715	3.5	3.6	LCB 8715	3.5	3.6	
P 40 C	LCB 0729	3.5	3.6	–	–	–	–	–	–	–	–	LCB 8729	3.5	3.6	LCB 8729	3.5	3.6		
P 50 C	LCB 0731	3.5	3.6	–	–	–	–	–	–	–	–	LCB 8731	3.5	3.6	LCB 8731	3.5	3.6		
PV 15	LCD 0276	3.5	3.6	LCD 4276	1.8	1.8	LCD 6276	1.4	1.4	–	–	–	–	–	–	–			
PV 24	LCD 0278	3.5	3.6	–	–	–	–	–	–	LCD 5278	2.8	2.9	LCD 8278	3.5	3.6	LCD 8278	3.5	3.6	
PV 36	LCD 0280	3.5	3.6	–	–	–	–	–	–	LCD 5280	2.8	2.9	LCD 8280	3.5	3.6	LCD 8280	3.5	3.6	
PV 15 C	LCD 0277	3.5	3.6	LCD 4277	1.8	1.8	LCD 6277	1.4	1.4	–	–	–	–	–	–	–			
PV 24 C	LCD 0279	3.5	3.6	–	1.8	1.8	–	1.4	1.4	LCD 5279	2.8	2.9	LCD 8279	3.5	3.6	LCD 8279	3.5	3.6	
PV 36 C	LCD 0281	3.5	3.6	–	1.8	1.8	–	1.4	1.4	LCD 5281	2.8	2.9	LCD 8281	3.5	3.6	LCD 8281	3.5	3.6	
PVL 15	LCD 0282	3.5	3.6	LCD 4282	1.8	1.8	LCD 6282	1.4	1.4	–	–	–	–	–	–	–			
PVL 24	LCD 0284	3.5	3.6	LCD 4284	1.8	1.8	LCD 6284	1.4	1.4	–	–	–	–	–	–	–			



Type	Cat. No.	Heater power kW	Loading kW	Cat. No.	Heater power kW	Loading kW	Cat. No.	Heater power kW	Loading kW
230 V; 50/60 Hz				115 V; 60 Hz			100 V; 50/60 Hz		
LAUDA Proline – single phase									
PVL 15 C	LCD 0283	3.5	3.6	LCD 4283	1.8	1.8	LCD 6283	1.4	1.4
PVL 24 C	LCD 0285	3.5	3.6	LCD 4285	1.8	1.8	LCD 6285	1.4	1.4
PB	LCG 0090	3.5	3.6	LCG 4090	1.8	1.8	LCG 6090	1.4	1.4
PB C	LCG 0091	3.5	3.6	LCG 4091	1.8	1.8	LCG 6091	1.4	1.4
PBD	LCG 0092	3.5	3.6	LCG 4092	1.8	1.8	LCG 6092	1.4	1.4
PBD C	LCG 0093	3.5	3.6	LCG 4093	1.8	1.8	LCG 6093	1.4	1.4

Type	Cat. No.	Heater power kW	Loading kW	Cat. No.	Heater power kW	Loading kW	Cat. No.	Heater power kW	Loading kW				
230 V; 50/60 Hz				230 V; 60 Hz			400 V; 3/N/PE; 50 Hz			440-480 V; 3/PE 60 Hz			
LAUDA Ultra – single phase													
USH 400	LTH 109	3.0	3.2	LTH 209	3.0	3.2	USH 400/6	LTH 211	5.6	5.8	LTH 611	5.6	5.8

Type	Cat. No.	Heater power kW	Loading kW	Type	Cat. No.	Heater power kW	Loading kW	Type	Cat. No.	Heater power kW	Loading kW	Type	Cat. No.	Heater power kW	Loading kW	Type	Cat. No.	Heater power kW	Loading kW								
230 V; 50/60 Hz				230 V; 50 Hz				230 V; 60 Hz				115 V; 60 Hz				200 V; 50/60 Hz				100 V; 50/60 Hz				208-220 V; 60 Hz			
LAUDA Calibration thermostats – single phase																											
RE 212 J	–	–	–	LCK 1879	2.25	2.3	LCK 2879	2.25	2.3	LCK 4879	1.3	1.4	–	–	–	–	–	–	–								
RE 312 J	–	–	–	LCK 1880	2.25	2.3	LCK 2880	2.25	2.3	LCK 4880	1.3	1.4	–	–	–	–	–	–	–								
PJ 12	LCB 0720	3.5	3.6	–	–	–	–	–	–	LCB 4720	1.8	1.8	LCB 5720	2.8	2.9	LCB 6720	1.4	1.4	LCB 8720	3.5	3.6						
PJ 12 C	LCB 0721	3.5	3.6	–	–	–	–	–	–	LCB 4721	1.8	1.8	LCB 5721	2.8	2.9	LCB 6721	1.4	1.4	LCB 8721	3.5	3.6						
PJL 12	LCB 0718	3.5	3.6	–	–	–	–	–	–	LCB 4718	1.8	1.8	LCB 5718	2.8	2.9	LCB 6718	1.4	1.4	LCB 8718	3.5	3.6						
PJL 12 C	LCB 0719	3.5	3.6	–	–	–	–	–	–	LCB 4719	1.8	1.8	LCB 5719	2.8	2.9	LCB 6719	1.4	1.4	LCB 8719	3.5	3.6						
UB 20 J	–	–	–	LTB 136	3.0	3.2	LTB 236	3.0	3.2	–	–	–	–	–	–	–	–	–	–								
UB 30 J	–	–	–	LTB 137	3.0	3.2	LTB 237	3.0	3.2	–	–	–	–	–	–	–	–	–	–								
UB 40 J	–	–	–	LTB 138	3.0	3.2	LTB 238	3.0	3.2	–	–	–	–	–	–	–	–	–	–								
UB 65 J	–	–	–	LTB 142	3.0	3.2	LTB 242	3.0	3.2	–	–	–	–	–	–	–	–	–	–								
UB 20 JL	–	–	–	LTB 143	3.0	3.2	LTB 243	3.0	3.2	–	–	–	–	–	–	–	–	–	–								
UB 30 JL	–	–	–	LTB 144	3.0	3.2	LTB 244	3.0	3.2	–	–	–	–	–	–	–	–	–	–								
UB 40 JL	–	–	–	LTB 145	3.0	3.2	LTB 245	3.0	3.2	–	–	–	–	–	–	–	–	–	–								
UB 20 F	–	–	–	LTB 139	1.2	3.2	LTB 239	3.0	3.2	–	–	–	–	–	–	–	–	–	–								

Type	Cat. No.	Heater power kW	Loading kW	Type	Cat. No.	Heater power kW	Loading kW	Type	Cat. No.	Heater power kW	Loading kW
230 V; 50 Hz				115 V; 60 Hz				100 V; 50/60 Hz			
LAUDA Alpha – single phase											
RA 8	LCKX 1907	1.5	1.8	LCKX 4907	1.15	1.5	LCKX 6907	1.0	1.3		
RA 12	LCKX 1908	1.5	1.8	LCKX 4908	1.15	1.5	LCKX 6908	1.0	1.3		
RA 24	LCKX 1909	1.5	1.8	LCKX 4909	1.15	1.5	LCKX 6909	1.0	1.3		

Type	Cat. No.	Heater power kW	Loading kW	Type	Cat. No.	Heater power kW	Loading kW	Type	Cat. No.	Heater power kW	Loading kW	Type	Cat. No.	Heater power kW	Loading kW
230 V; 50 Hz				220 V; 60 Hz				115 V; 60 Hz				100 V; 50/60 Hz			
LAUDA ECO – single phase															
RE 415 S	LCK 1910	1.3	1.6	LCK 2910	1.2	1.5	LCK 4910	1.3	1.6	LCK 6910	1.0	1.3			
RE 420 S	LCK 1912	1.3	1.6	LCK 2912	1.2	1.5	LCK 4912	1.3	1.6	LCK 6912	1.0	1.3			
RE 620 S	LCK 1914	1.3	1.6	LCK 2914	1.2	1.5	LCK 4914	1.3	1.6	LCK 6914	1.0	1.3			
RE 630 S	LCK 1916	1.3	1.7	LCK 2916	1.2	1.6	LCK 4916	1.3	1.7	LCK 6916	1.0	1.4			
RE 1050 S	LCK 1918	1.3	2.0	LCK 2918	1.2	1.9	LCK 4918	1.3	2.0	LCK 6918	1.0	1.7			
RE 1225 S	LCK 1920	1.3	1.7	LCK 2920	1.2	1.6	LCK 4920	1.3	1.7	LCK 6920	1.0	1.4			
RE 2025 S	LCK 1922	1.3	1.7	LCK 2922	1.2	1.6	LCK 4922	1.3	1.7	LCK 6922	1.0	1.4			
RE 415 G	LCK 1911	2.6	2.8	LCK 2911	2.4	2.6	LCK 4911	1.3	1.5	LCK 6911	1.0	1.2			
RE 420 G	LCK 1913	2.6	2.8	LCK 2913	2.4	2.6	LCK 4913	1.3	1.5	LCK 6913	1.0	1.2			
RE 620 G	LCK 1915	2.6	2.8	LCK 2915	2.4	2.6	LCK 4915	1.3	1.5	LCK 6915	1.0	1.2			
RE 630 G	LCK 1917	2.6	2.9	LCK 2917	2.4	2.7	LCK 4917	1.3	1.6	LCK 6917	1.0	1.3			
RE 1050 G	LCK 1919	2.6	3.3	LCK 2919	2.4	3.1	LCK 4919	1.3	2.0	LCK 6919	1.0	1.7			
RE 1225 G	LCK 1921	2.6	2.9	LCK 2921	2.4	2.7	LCK 4921	1.3	1.6	LCK 6921	1.0	1.3			
RE 2025 G	LCK 1923	2.6	2.9	LCK 2923	2.4	2.7	LCK 4923	1.3	1.6	LCK 6923	1.0	1.3			
RE 415 SW	LCK 1924	1.3	1.6	LCK 2924	1.2	1.5	LCK 4924	1.3	1.6	LCK 6924	1.0	1.3			
RE 420 SW	LCK 1926	1.3	1.6	LCK 2926	1.2	1.5	LCK 4926	1.3	1.6	LCK 6926	1.0	1.3			
RE 620 SW	LCK 1928	1.3	1.6	LCK 2928	1.2	1.5	LCK 4928	1.3	1.6	LCK 6928	1.0	1.3			
RE 630 SW	LCK 1930	1.3	1.7	LCK 2930	1.2	1.6	LCK 4930	1.3	1.7	LCK 6930	1.0	1.4			
RE 1050 SW	LCK 1932	1.3	2.0	LCK 2932	1.2	1.9	LCK 4932	1.3	2.0	LCK 6932	1.0	1.7			
RE 1225 SW	LCK 1934	1.3	1.7	LCK 2934	1.2	1.6	LCK 4934	1.3	1.7	LCK 6934	1.0	1.4			
RE 2025 SW	LCK 1936	1.3	1.7	LCK 2936	1.2	1.6	LCK 4936	1.3	1.7	LCK 6936	1.0	1.4			
RE 415 GW	LCK 1925	2.6	2.8	LCK 2925	2.4	2.6	LCK 4925	1.3	1.5	LCK 6925	1.0	1.2			
RE 420 GW	LCK 1927	2.6	2.8	LCK 2927	2.4	2.6	LCK 4927	1.3	1.5	LCK 6927	1.0	1.2			
RE 620 GW	LCK 1929	2.6	2.8	LCK 2929	2.4	2.6	LCK 4929	1.3	1.5	LCK 6929	1.0	1.2			
RE 630 GW	LCK 1931	2.6	2.9	LCK 2931	2.4	2.7	LCK 4931	1.3	1.6	LCK 6931	1.0	1.3			
RE 1050 GW	LCK 1933	2.6	3.3	LCK 2933	2.4	3.1	LCK 4933	1.3	2.0	LCK 6933	1.0	1.7			
RE 1225 GW	LCK 1935	2.6	2.9	LCK 2935	2.4	2.7	LCK 4935	1.3	1.6	LCK 6935	1.0	1.3			
RE 2025 GW	LCK 1937	2.6	2.9	LCK 2937	2.4	2.7	LCK 4937	1.3	1.6	LCK 6937	1.0	1.3			



LAUDA Power supply variants



Power supply variants

Type	Cat. No.	Heater power kW	Loading kW	Cat. No.	Heater power kW	Loading kW	Cat. No.	Heater power kW	Loading kW	Cat. No.	Heater power kW	Loading kW	Cat. No.	Heater power kW	Loading kW	
		230 V; 50 Hz			115 V; 60 Hz			200 V; 50/60 Hz			100 V; 50/60 Hz			208-220 V; 60 Hz		
LAUDA Proline – single phase																
RP 845	LCK 1885	3.5	3.6	LCK 4885	1.75	1.8	LCK 5885	2.7	3.2	LCK 6885	1.3	1.6	LCK 8885	2.9	3.6	
RP 855	LCK 1893	3.5	3.6	-	-	-	LCK 5893	2.7	3.2	-	-	-	LCK 8893	2.9	3.6	
RP 870	LCK 1895	3.5	3.6	-	-	-	LCK 5895	2.7	3.2	-	-	-	LCK 8895	2.9	3.6	
RP 890	LCK 1897	3.5	3.6	-	-	-	LCK 5897	2.7	3.2	-	-	-	LCK 8897	2.9	3.6	
RP 1290	LCK 1899	3.5	3.6	-	-	-	LCK 5899	2.7	3.2	-	-	-	LCK 8899	2.9	3.6	
RP 1840	LCK 1887	3.5	3.6	LCK 4887	1.75	1.8	LCK 5887	2.7	3.2	LCK 6887	1.3	1.6	LCK 8887	2.9	3.6	
RP 1845	LCK 1891	3.5	3.6	-	-	-	LCK 5891	2.7	3.2	-	-	-	LCK 8891	2.9	3.6	
RP 3530	LCK 1889	3.5	3.6	LCK 4889	1.75	1.8	LCK 5889	2.7	3.2	LCK 6889	1.3	1.6	LCK 8889	2.9	3.6	
RP 845 C	LCK 1886	3.5	3.6	LCK 4886	1.75	1.8	LCK 5886	2.7	3.2	LCK 6886	1.3	1.6	LCK 8886	2.9	3.6	
RP 855 C	LCK 1894	3.5	3.6	-	-	-	LCK 5894	2.7	3.2	-	-	-	LCK 8894	2.9	3.6	
RP 870 C	LCK 1896	3.5	3.6	-	-	-	LCK 5896	2.7	3.2	-	-	-	LCK 8896	2.9	3.6	
RP 890 C	LCK 1898	3.5	3.6	-	-	-	LCK 5898	2.7	3.2	-	-	-	LCK 8898	2.9	3.6	
RP 1290 C	LCK 1900	3.5	3.6	-	-	-	LCK 5900	2.7	3.2	-	-	-	LCK 8900	2.9	3.6	
RP 1840 C	LCK 1888	3.5	3.6	LCK 4888	1.75	1.8	LCK 5888	2.7	3.2	LCK 6888	1.3	1.6	LCK 8888	2.9	3.6	
RP 1845 C	LCK 1892	3.5	3.6	-	-	-	LCK 5892	2.7	3.2	-	-	-	LCK 8892	2.9	3.6	
RP 3530 C	LCK 1890	3.5	3.6	LCK 4890	1.75	1.8	LCK 5890	2.7	3.2	LCK 6890	1.3	1.6	LCK 8890	2.9	3.6	
		400 V; 3/N/PE; 50 Hz			208 V; 3/PE; 60 Hz			200 V; 3/PE; 50/60 Hz								
LAUDA Proline Kryomats – three phase																
RP 3050 C	LUK 239	3.5	5.0	LUK 339	3.0	5.0	LUK 439	2.8	5.0							
RP 4050 C	LUK 241	3.5	5.0	LUK 341	3.0	5.0	LUK 441	2.8	5.0							
RP 3090 C	LUK 245	3.5	5.0	LUK 345	3.0	5.0	LUK 445	2.8	5.0							
RP 4090 C	LUK 247	3.5	5.0	LUK 347	3.0	5.0	LUK 447	2.8	5.0							
RP 3050 CW	LUK 240	3.5	5.0	LUK 340	3.0	5.0	LUK 440	2.8	5.0							
RP 4050 CW	LUK 242	3.5	5.0	LUK 342	3.0	5.0	LUK 442	2.8	5.0							
RP 3090 CW	LUK 246	3.5	5.0	LUK 346	3.0	5.0	LUK 446	2.8	5.0							
RP 4090 CW	LUK 248	3.5	5.0	LUK 348	3.0	5.0	LUK 448	2.8	5.0							
		230 V; 50 Hz			230 V; 60 Hz			208-230 V; 60 Hz			200 V; 50 Hz			200 V; 60 Hz		
LAUDA Integral T – single phase																
T 1200	LWP 101	2.25	2.7	-	-	-	LWP 801	1.85	2.7	LWP 811	1.7	2.7	-	-	-	
T 1200 W	LWP 102	2.25	2.7	-	-	-	LWP 802	1.85	2.7	-	-	-	-	-	-	
T 2200	LWP 103	2.25	3.1	LWP 203	2.25	3.1	LWP 803	1.85	3.1	-	-	-	LWP 846	1.7	3.1	
T 2200 W	LWP 104	2.25	3.1	LWP 204	2.25	3.1	LWP 804	1.85	3.1	-	-	-	-	-	-	
		400 V; 3/N/PE; 50 Hz			208 V; 3/PE; 60 Hz			400 V; 3/PE; 50 Hz			440-480 V; 3/PE; 60 Hz					
LAUDA Integral T – three phase																
T 4600	LWP 205	6.0	8.5	LWP 305	4.9	8.5	LWP 505	6.0	8.5	-	-	-	-	-	-	
T 4600 W	LWP 206	6.0	8.3	LWP 306	4.9	11.5	-	-	-	-	-	-	-	-	-	
T 7000	LWP 207	6.0	11.5	-	-	-	LWP 507	6.0	8.3	LWP 607	5.3	11.5	-	-	-	
T 7000 W	LWP 208	6.0	11.2	-	-	-	-	-	-	LWP 608	5.3	11.2	-	-	-	
T 10000	LWP 209	9.0	16.0	-	-	-	-	-	-	LWP 609	7.95	15.0	-	-	-	
T 10000 W	LWP 210	9.0	15.5	-	-	-	-	-	-	LWP 610	7.95	14.5	-	-	-	
		230 V; 50 Hz			200 V; 50/60 Hz			208-220 V; 60 Hz								
LAUDA Integral XT – single phase																
XT 150	LWP 112	3.5	3.68	LWP 512	2.65	3.2	LWP 812	2.9	3.5							
XT 250 W	LWP 113	3.5	3.68	LWP 513	2.65	3.2	LWP 813	2.9	3.5							
XT 350 W	LWP 117	3.5	3.68	LWP 517	2.65	3.2	LWP 817	2.9	3.5							
XT 350 HW	LWP 119	3.5	3.68	LWP 519	2.65	3.2	LWP 819	2.9	3.5							
		208-220 V; 3/PE; 60 Hz			200 V; 3/PE; 50/60 Hz			400 V; 3/PE; 50 Hz			440-480 V; 3/PE; 60 Hz			400 V; 3/PE; 50 Hz & 440-480 V; 3/PE; 60 Hz		
LAUDA Integral XT – three phase																
XT 280	LWP 334	3.0	8.5	LWP 434	2.7	8.0	LWP 534	4.0	9.0	-	-	-	-	-	-	
XT 750	LWP 320	5.7	7.6	LWP 420	5.3	6.9	LWP 520	5.3	7.8	-	-	-	-	-	-	
XT 750 H	LWP 322	5.7	7.6	LWP 422	5.3	6.9	LWP 522	5.3	7.8	-	-	-	-	-	-	
XT 490 W	LWP 339	5.7	9.5	LWP 439	5.3	8.6	LWP 539	5.3	9.0	-	-	-	-	-	-	
XT 950 W	LWP 321	5.7	7.6	LWP 421	5.3	6.9	LWP 521	5.3	7.8	-	-	-	-	-	-	
XT 1850 W	-	-	-	-	-	-	LWP 532	10.6	13.8	LWP 632	14.0	20.8	LWP 732	10.6 & 14.0	20.8	
XT 1850 WS	-	-	-	-	-	-	LWP 533	16.0	17.3	-	-	-	-	-	-	
XT 1590 W	-	-	-	-	-	-	LWP 542	5.3	13.8	LWP 642	7.0	16.6	LWP 742	5.3 & 7.0	16.6	



Type	Cat. No.	Loading kW	Cat. No.	Loading kW	Cat. No.	Loading kW	Cat. No.	Loading kW	Cat. No.	Loading kW	Cat. No.	Loading kW	Cat. No.	Loading kW
230 V; 50/60 Hz			230 V; 50 Hz		230 V; 60 Hz		115 V; 60 Hz		100 V; 50 Hz/115 V; 60 Hz		220 V; 60 Hz		208-230 V; 60 Hz	
LAUDA WK class – single phase														
WK 300	–	–	LWM 117	0.35	–	–	–	–	LWM 717	0.4	–	–	–	–
WK 500	–	–	LWG 132	0.47	LWG 232	0.47	–	–	LWG 732	0.6	–	–	–	–
WK 502	–	–	LWG 140	0.9	LWG 240	1.0	–	–	–	–	–	–	–	–
WK 1200	–	–	LWG 133	1.2	LWG 233	1.2	–	–	LWG 733	1.4	–	–	–	–
WK 1200 W	–	–	LWG 161	1.2	LWG 261	1.2	–	–	LWG 761	1.2	–	–	–	–
WK 1400	–	–	LWG 137	1.0	LWG 237	1.0	–	–	LWG 737	1.0	–	–	–	–
WK 1400 W	–	–	LWG 162	1.0	LWG 262	1.0	–	–	LWG 762	1.0	–	–	–	–
WK 2200	–	–	LWG 134	1.6	LWG 234	1.6	–	–	–	–	–	–	LWG 834	1.6
WK 2200 W	–	–	LWG 163	1.6	LWG 263	1.6	–	–	–	–	–	–	LWG 863	1.6
WK 2400	–	–	LWG 138	1.4	LWG 238	1.4	–	–	–	–	–	–	–	–
WK 2400 W	–	–	LWG 164	1.4	LWG 264	1.4	–	–	–	–	–	–	–	–
WKL 230	LWM 016	0.3	–	–	–	–	–	–	LWM 716	0.5	–	–	–	–
WKL 600	–	–	LWG 141	0.7	LWG 241	0.7	–	–	LWG 741	0.83	–	–	–	–
WKL 603	–	–	LWG 142	0.9	LWG 242	0.9	–	–	LWG 742	0.9	–	–	–	–
WKL 900	–	–	LWG 159	0.8	–	–	–	–	LWG 759	0.8	–	–	LWG 859	0.8
WKL 903	–	–	LWG 160	1.0	–	–	–	–	LWG 760	1.0	–	–	LWG 860	1.0
WKL 1000	–	–	LWG 173	1.1	LWG 273	1.1	LWG 473	1.0	–	–	–	–	–	–
WKL 1200	–	–	LWG 153	1.6	–	–	–	–	–	–	–	–	LWG 853	1.6
WKL 1200 W	–	–	LWG 166	1.6	–	–	–	–	–	–	–	–	LWG 866	1.6
WKL 2200	–	–	LWG 154	2.2	–	–	–	–	–	–	–	–	LWG 854	2.2
WKL 2200 W	–	–	LWG 167	2.2	–	–	–	–	–	–	–	–	LWG 867	2.2
WK 3200	–	–	LWG 139	3.0	–	–	–	–	–	–	LWG 839	3.0	–	–
WKL 3200	–	–	–	–	–	–	–	–	–	–	LWG 874	3.0	–	–
230 V; 3/PE; 50 Hz			230V; 3/PE; 60 Hz		400 V; 3/N/PE; 50 Hz		208 V; 3/PE; 60 Hz		440-480 V; 3/PE; 60 Hz		200 V; 3/PE; 60 Hz		208-230 V; 3/PE; 60 Hz	
LAUDA WK class – three phase														
WK 3200	LWG 035	2.0	LWG 135	2.0	LWG 235	2.0	–	–	–	–	–	–	–	–
WK 3200 W	–	–	LWG 165	2.0	LWG 265	2.0	LWG 765	2.0	–	–	–	–	–	–
WK 4600	–	–	–	–	LWG 236	2.5	–	–	LWG 636	2.5	–	–	LWG 336	2.5
WK 4600 W	–	–	LWG 158	2.3	LWG 258	2.3	–	–	–	–	–	–	LWG 758	2.3
WK 7000	–	–	LWG 145	5.5	LWG 245	5.0	LWG 345	5.0	LWG 645	5.0	LWG 745	5.0	–	–
WK 7000 W	–	–	–	–	LWG 247	4.7	LWG 347	4.8	LWG 647	4.8	LWG 770	5.0	–	–
WK 10000	–	–	–	–	LWG 249	6.5	–	–	LWG 649	7.0	LWG 749	7.0	–	–
WK 10000 W	–	–	–	–	LWG 251	6.0	–	–	LWG 651	6.0	LWG 751	6.0	–	–
WKL 3200	–	–	LWG 155	3.5	LWG 255	2.8	LWG 755	3.5	LWG 655	2.8	–	–	–	–
WKL 3200 W	–	–	–	–	LWG 268	2.8	–	–	–	–	–	–	LWG 768	2.8
WKL 4600	–	–	–	–	LWG 256	3.5	–	–	–	–	–	–	LWG 756	3.5
WKL 4600 W	–	–	–	–	LWG 257	3.3	–	–	–	–	–	–	LWG 757	3.3
WKL 7000	–	–	–	–	LWG 246	5.5	LWG 346	5.5	LWG 646	5.5	–	–	–	–
WKL 7000 W	–	–	–	–	LWG 248	5.2	LWG 348	5.2	LWG 648	5.2	–	–	–	–
WKL 10000	–	–	–	–	LWG 250	7.0	–	–	LWG 650	7.0	LWG 750	7.0	–	–
WKL 10000 W	LWG 052	6.5	–	–	LWG 252	6.5	–	–	LWG 652	6.5	–	–	–	–

LAUDA Glossary

Device functions

EasyUse operation (Proline)

Drain taps, castors and handles for increased mobility, double pump connections for the parallel connection of two external systems, switching of the circulation (bypass), removable Command remote control, and quick change of the required interfaces.

External control

The temperature of the thermostat is controlled via a temperature probe connected to the external system. The set value is compared with the actual value in the external system and readjusted within the thermostat. Depending on the operating temperature, insulation losses and exothermia, the bath temperature can be considerably above or below the set value. External control ensures that the bath temperature and application temperature are constant.

PowerAdapt System (Proline)

The maximum possible heating capacity is used as far as is permitted by the net. Advantage: up to 3.5 kW heating capacity even with cooling thermostats, shorter heating times and no overloading of the net. The patented LAUDA heater control minimises the loading effects on the laboratory's voltage network. Moreover, the maximum power consumption can be reduced to 10 A as required.

Proportional cooling (Kryomats, Process thermostats)

The cooling capacity is quasi-proportionally set according to the controller signal. This produces savings of around 75 percent compared to standard cooling that uses cooling and counter-cooling. The automatic cooling capacity adjustment also switches the cooling unit off completely should no cooling be required for a longer period of time.

SelfCheck Assistant (Proline, Integral XT)

The SelfCheck Assistant checks all parameters before the actual start of operations and the switch-off methods of the heater control in particular. The system registers not only alarm or error messages on the display: it also points out scheduled maintenance tasks such as cleaning of the cooling grid.

SmartCool System (Proline)

A special form of proportional cooling combined with a regulated ventilator.

Types of device

Bath/circulation thermostat

Is a bath thermostat with a circulating pump for closed or open external circuits.

Bath thermostat

Is a thermostat which is equipped with a bath capable of holding the object to be thermostated. The built-in circulation pump is used to mix the bath liquid, but can also be used to convey the liquid through a closed external circuit, e.g. the connection of through-flow coolers, if required.

Calibration thermostat

Is a bath thermostat with especially high temperature stability and especially consistent spatial temperature distribution. It is used mainly for the calibration and adjustment of test pieces in the bath.

Circulation chiller (also circulating chiller)

Are special cooling thermostats designed as circulation thermostats without a freely-accessible bath. Thanks to their construction, they are independent devices which are frequently used as a replacement for the cooling with mains water.

Circulation heat exchanger

Is an add-on cooler which, via a heat exchanger, uses an existing primary cooling circuit to cool various external systems.

Circulation thermostat

Is a thermostat without freely-accessible bath, through which the bath liquid is conveyed through an open or closed external circuit.

Clear-view thermostat

Is a bath thermostat with transparent front and back to enable viewing of an object to be thermostated, usually a viscometer. Bath thermostats with transparent polycarbonate baths are known as thermostats with transparent bath.

Cooling thermostat

Is a thermostat whose working temperature range is below the ambient temperature and which does not have any heating.

Heating and cooling thermostat

Is a thermostat whose working temperature range is above and below the ambient temperature and which can both heat and cool.

Heating thermostat

Is a thermostat whose working temperature range is above the ambient temperature and which can only heat.

Immersion thermostat

Is a thermostat which can be combined with any bath. It is attached to the side of the bath or on a stand by means of a screw clamp.

Immersion cooler

Is an add-on cooler which is connected by means of a flexible tube to a cooling coil for immersion in any bath or vessel.

Kryomat

Is a floor-mounted heating and cooling thermostat in three different levels with various cooling and pump capacities.

Process thermostats (Integral T, Integral XT)

Are circulation thermostats used as heating and cooling thermostats with high cooling, heating and pump capacities. Small volumes of liquid enable quick cooling-down and heating speeds: they are ideal for process technology applications.

Through-flow cooler

Is an add-on cooler which can be interconnected in an external circuit and which extends the function of a heating thermostat to that of a heating and cooling thermostat. It replaces water cooling or can be used to achieve lower temperatures (down to -40 °C with the DLK 45/DLK 45 LiBus).

Ultra thermostats

Are heating thermostats used as bath/circulation thermostats or as pure circulation thermostats with spatially-separated bath and control unit. This enables remote control and monitoring.

Water bath

Is a heating bath which does not have a pump for active mixing purposes and which is only equipped for use with water.

Refrigeration technology

Cooling capacity

Is the effective capacity available in a cooling thermostat or circulation chiller. Losses caused by the circulating pump and invasive heat have already been deducted.

Cooling cascades

If temperatures below -50 °C are to be produced with compressor cooling units, two-stage cooling units connected in cascades are required to bridge the difference between the cold side (evaporation pressure) and warm side (condensation pressure, e.g. ambient temperature). The high-pressure stage bridges the temperature difference from approx. ambient temperature to -40 °C, for example. The low-temperature stage provides the final temperature of -90 °C, for example.

Refrigerant

Is used in the circuit of the cooling unit and extracts the heat of the thermostating liquid when the compressed gas expands and evaporates in the evaporator. LAUDA only uses refrigerants with ODP = 0 which do not destroy the ozone layer (ODP = ozone depleting potential).

Pumps

Pressure pump

Is used for the circulation of the bath liquid in a closed external circuit and for mixing the liquid within the bath.

Vario pump (ECO, Integral XT)

Is a pressure pump which can be set to various output stages with regard to flow rate and flow pressure. This enables the optimum adaptation to the corresponding application.

Varioflex pump (Proline)

Is a pressure/suction pump with 8 different pump capacity settings to be connected to open and closed circuits. Its low energy input makes working at the lowest temperatures possible. The Varioflex pump is available in a high-power model as a pure pressure pump for devices with deeper baths. The patented low-level protection (DGM) is an additional safety advantage.

Technical data of LAUDA devices

ACC range (Active Cooling Control): according to DIN 12876

This is the working temperature range during operation with an active cooling unit. The working temperature range is equal to the ACC range in all LAUDA devices.

Ambient temperature range

This is the permissible temperature range of the environment in which the device works properly. It is 5...35 °C for all LAUDA devices contained within this brochure with the exception of the Integral and the WK devices, where the latter is extended to 40 °C. This is particularly important with respect to industrial applications.

Bath depth

Is the overall dimension from the upper edge to the bottom of the bath.

Bath opening

Is the usable surface available for direct thermostating, as a rule over the entire usable depth.

Bath volume (also filling volume)

Is the volume of the bath liquid that is required for the appropriate operation of the thermostat in the bath. The required minimum volume and the permitted maximum volume are usually given. The difference is the expansion volume, which must absorb the heat expansion of the bath liquid. The expansion volume is especially large with process thermostats.

Discharge pressure

Is the pressure of the circulation pump of a thermostat directly at the pressure nozzle, measured with water. In the tables, the maximum discharge pressure is given at flow rate zero. The diagrams illustrate the discharge pressure is dependent upon the flow rate.

Discharge suction

This is the suction of the circulation pump (Varioflex or Duplex pump) directly at the suction nozzle, measured with water. In the tables, the maximum suction is given at flow rate zero. The diagrams illustrate the discharge suction is dependent upon the flow rate.

Display resolution

Is given with regard to the digital temperature display of the actual value, and displays the temperature difference between two subsequent numbers.

Flow rate

Is the volume of liquid conveyed per time unit by the circulation pump, measured with water. In the tables, the maximum flow rate is given at counter pressure zero. The diagrams illustrate the discharge pressure is dependent upon the flow rate.

Heating capacity

This is the maximum electrical capacity of the installed heater at the given nominal voltage. The heating capacity of LAUDA thermostats may be controlled if required.

Interface, analogue

Is used to input the set value of the temperature/to output temperature values or other values in analogue form, usually as a reference signal with voltage (0...10 V) or current (0/4...20 mA). Relevant LAUDA interfaces are adjustable and scalable.

Interface, digital

Is used to exchange digital data, mainly set and actual temperature values. The RS 232 interface is of a serial type and allows a point-to-point connection. This means that only two participants can communicate at a time with each other via the interface. The RS 485 interface is an addressable interface to which up to 32 participants with their own address may be connected.

International protection, IP

As per EN 60529. The first digit indicates the protection against contact and foreign objects, whereas the second digit indicates protection against water. For example, IP 32: 3 stands for protection against contact with dangerous parts located inside with a tool of greater than/equal to 2.5 mm diameter and up to 100 mm in length. 2 stands for protection against dripping water at angles of 15 °. The assessment is carried out as per EN 61010-1. The LAUDA range only provides IP information for process thermostats and circulation chillers.

Intrinsic temperature

Is the operating temperature of a heating thermostat attained when the thermostat is switched off. It depends on the pump capacity, the heat transfer liquid used and the insulation of the thermostats. The working temperature range only starts approx. 3 °C above the intrinsic temperature.

Operating temperature range

This is the temperature range defined by the lowest and highest permissible operating temperature. As a rule, this is only given for heating thermostats whose working temperature range can be extended to lower temperatures by means of auxiliary equipment.

Profibus

Is a bus system with a high signal transfer rate for connecting up to 256 devices and is used mainly in the chemical industry.

Resolution setting

Is the difference between two consecutive set values of a digital set value setting.

Safety classes

It is possible to use non-flammable or flammable bath liquids in thermostats. The relevant safety-related requirements are stipulated in DIN EN 61010-2-010. According to DIN 12876-1, we make a distinction between class I with the distinction NFL (non-flammable) with built-in overtemperature protection exclusively for non-flammable liquids, and class III with the distinction FL (flammable) with adjustable overtemperature protection and low level protection for flammable liquids.

Sound pressure level

Is measured according to the guidelines given in DIN EN ISO 11200 and the basic standards contained therein.

Standards

The safety regulations for electric laboratory equipment are stipulated in the European standards EN 61010-1 and EN 61010-2010. The terms and the stipulation of the characteristic data are described in DIN 12876. EMC requirements are stipulated in EN 61356. Depending on the device, further standards may be applied.

Temperature stability

This is half of the temperature difference between the highest and the lowest temperatures which are measured at a specific set value after attaining a stable value for 30 minutes in a thermostat. The details are provided at 70 °C (using water) for a heating thermostat and at -10 °C (using ethanol) for a cooling thermostat.

Usable depth

Is the maximum liquid depth available in the bath thermostat for direct thermostating.

Working temperature range

This is the temperature range which can be attained at an ambient temperature of 20 °C by the thermostat alone and with the exclusive use of electrical energy and without any other aid. The working temperature range of a heating thermostat begins above the ambient temperature and ends at the upper limit of the operating temperature.

Our product lines:

Thermostats · Circulation chillers · Water baths
Process cooling systems · Heat transfer systems · Secondary circuit systems
Viscometers · Tensiometers



1-238-e-1/5.10 – Subject to technical changes.

LAUDA-Brinkmann, LP
1819 Underwood Boulevard · 08075 Delran, NJ · USA · North America
Phone: +1 856 764 7300 · Fax: +1 856 764 7307
E-mail: info@lauda-brinkmann.com · Internet: www.lauda-brinkmann.com

LAUDA DR. R. WOBSEER GMBH & CO. KG
P.O. Box 1251 · 97912 Lauda-Königshofen · Germany
Phone: +49 (0)9343 503-0 · Fax: +49 (0)9343 503-222
E-mail: info@lauda.de · Internet: www.lauda.de